

DC ONE

MANUALE UTENTE - USER MANUAL
BENUTZERHANDBUCH - MANUAL DE USUARIO
NOTICE POUR L'UTILISATEUR

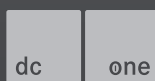

DALLA
CORTE



DC ONE

1.0 MANUALE UTENTE

Dotazione del macinacaffè	6
Avvertenze generali	7
Predisposizione dell'installazione	8
Messa in funzione del macinacaffè	10
Regolazioni	10
Schema di flusso dei menù	11
Manutenzione ordinaria	19
Allarmi	20

3.0 BENUTZERHANDBUCH

Zubehör	42
Allgemeine hinweise	43
Installationsanweisungen	44
Inbetriebnahme der kaffeemühle	46
Einstellungen und regulierung	46
Flussschema der menüs	47
Planmässige wartung	55
Alarmmeldungen	56

2.0 USER MANUAL

Coffee grinder accessories	24
General notes	25
Setting up for installation	26
Starting the grinder	28
Settings and adjustments	28
Menus flow chart	29
Ordinary maintenance	37
Alarm	38

4.0 MANUAL DE USUARIO

Dotación del molino	60
Advertencias generales	61
Preparación para la instalación	62
Puesta en funcionamiento del molino de café	64
Ajustes	64
Esquema de flujo de los menús	65
Mantenimiento ordinario	73
Alarmas	74

5.0 NOTICE POUR L'UTILISATEUR

Accessoires du moulin à café	78
Instructions générales	79
Préparatifs pour l'installation	80
Mise en marche du moulin à café	82
Réglages	82
Schéma de principes des menus	83
Entretien de routine	91
Alarmes	92



1.0

MANUALE UTENTE

Congratulazioni per l'acquisto di questo macinacaffè

Questo macinacaffè combina molteplici caratteristiche innovative quali una rivoluzionaria tecnologia, un design ergonomico, un altissimo standard qualitativo dei materiali e un'estrema facilità d'uso.

Questo manuale è strutturato in modo tale da essere uno strumento utile per familiarizzare con l'uso del macinacaffè. In esso troverete tutte le informazioni importanti inerenti alle caratteristiche di funzionamento, le informazioni tecniche, le istruzioni per l'uso e la corretta manutenzione. Prestando attenzione a quanto contenuto in questo manuale scoprirete di poter ottenere prestazioni di alto livello. Sfogliate e seguite passo passo ciò che segue e prendetevi il tempo necessario per scoprire il vostro macinacaffè in tutti i suoi dettagli.

Dotazione del macinacaffè

- Manuale di utilizzo per l'utente
- Pennello per la pulizia
- Raccoglitore caffè macinato
- Prodotto per la pulizia interna (campionatura per una pulizia)

Avvertenze generali

ATTENZIONE

Questo apparecchio è destinato solo all'uso professionale per il quale è stato concepito.

Ogni altro uso è da considerarsi improprio e quindi irragionevole. Il costruttore non può essere considerato responsabile per eventuali danni causati da usi impropri, erronei ed irragionevoli.

L'uso di questo apparecchio deve avvenire esclusivamente da personale professionalmente qualificato.

Leggere attentamente le istruzioni e avvertenze contenute nel presente manuale in quanto forniscono importanti indicazioni riguardanti l'uso dell'apparecchio e il suo funzionamento.

In caso di sostituzione del cavo di alimentazione dell'apparecchio, utilizzare solo il cavo consigliato dal costruttore.

La sicurezza elettrica è raggiunta solo quando l'impianto elettrico a cui si collega l'apparecchio è correttamente **collegato ad un impianto di messa a terra.**

È necessario far verificare questo fondamentale requisito da personale qualificato. Il costruttore e l'installatore non possono essere considerati responsabili per eventuali danni causati dalla mancanza o inefficienza della messa a terra dell'impianto.

L'utilizzo di qualsiasi apparecchio elettrico comporta inoltre l'osservanza di alcune regole fondamentali:

- non usare l'apparecchio con le mani o con i piedi bagnati o a piedi nudi.
- L'apparecchio non è destinato a essere usato da persone (bambini compresi) le cui capacità fisiche, sensoriali o mentali siano ridotte, oppure con mancanza di esperienza o di conoscenza, salvo che abbiano potuto beneficiare, attraverso

l'intermediazione di una persona responsabile della loro sicurezza, di una sorveglianza o istruzioni riguardanti l'uso dell'apparecchio.

- Prima di compiere qualsiasi operazione di pulizia o di manutenzione ordinaria, disinserire l'apparecchio dalla rete di alimentazione elettrica.
- Per pulire l'apparecchio non lavarlo con un getto d'acqua, né immergerlo in acqua.
- Non lasciare l'apparecchio acceso e incustodito per lunghi periodi (es. 1 giorno).
- Per garantire l'efficienza dell'apparecchio e per il suo corretto funzionamento è indispensabile attenersi alle indicazioni del costruttore, eseguendo la manutenzione ordinaria.
- La temperatura dell'ambiente di lavoro dell'apparecchio deve essere compresa tra minimo 5° e massimo 35°C.

Nel caso di una temporanea permanenza in ambiente con temperatura inferiore a 0°, rivolgersi esclusivamente al proprio Servizio Assistenza Tecnica autorizzato dal costruttore.

- In caso di guasto e/o di cattivo funzionamento dell'apparecchio, spegnerlo, astenendosi da qualsiasi tentativo di riparazione diretta. Rivolgersi quindi esclusivamente al proprio Servizio Assistenza Tecnica autorizzato dal costruttore.

GCS (GRINDER CONTROL SYSTEM)

Questo macinacaffè ha un sistema elettronico di gestione che prevede la possibilità di programmare il tempo di macinazione e la macinatura.

Il macinacaffè può inoltre essere regolato automaticamente se collegato con l'apposito cavo seriale ad una macchina da caffè Dalla Corte serie evolution o dc pro.

Questo sistema controlla e regola la macinatura tramite la macchina da caffè espresso, che monitora ogni erogazione di caffè e, quando i parametri di estrazione non sono conformi a quelli programmati in fase d'installazione del sistema, invia al macinacaffè il comando di modifica della grandezza della macinatura e del tempo di macinazione.

Predisposizione dell'installazione

ATTENZIONE

L'installazione deve essere effettuata in ottemperanza alle leggi vigenti, secondo le istruzioni del costruttore e da personale qualificato. Un'errata installazione può causare danni a persone, animali e cose. Il costruttore non può essere considerato responsabile per i danni causati da un'errata installazione.

Per l'installazione di questo apparecchio predisporre, vicino alla macchina per caffè, un piano di appoggio stabile e sicuro largo 30 cm e profondo 40cm che garantisca un'altezza utile di 70cm.

Installare inoltre una presa di corrente monofase da 10-16 amp del tipo previsto dalle normative locali del luogo d'installazione.

Dopo aver tolto l'imballo verificare l'integrità dell'apparecchio. In caso di dubbio, non utilizzarlo.

Gli elementi dell'imballaggio non devono essere lasciati alla portata dei bambini in quanto potenziali fonti di pericolo.

Prima di collegare l'apparecchio all'impianto elettrico accertarsi che i dati di targa corrispondano a quelli del luogo d'installazione.

In caso sia necessario sostituire il cavo di alimentazione dell'apparecchio, rivolgersi all'installatore dello stesso.



Descrizione generale e messa in funzione del macinacaffè

Fig. 1

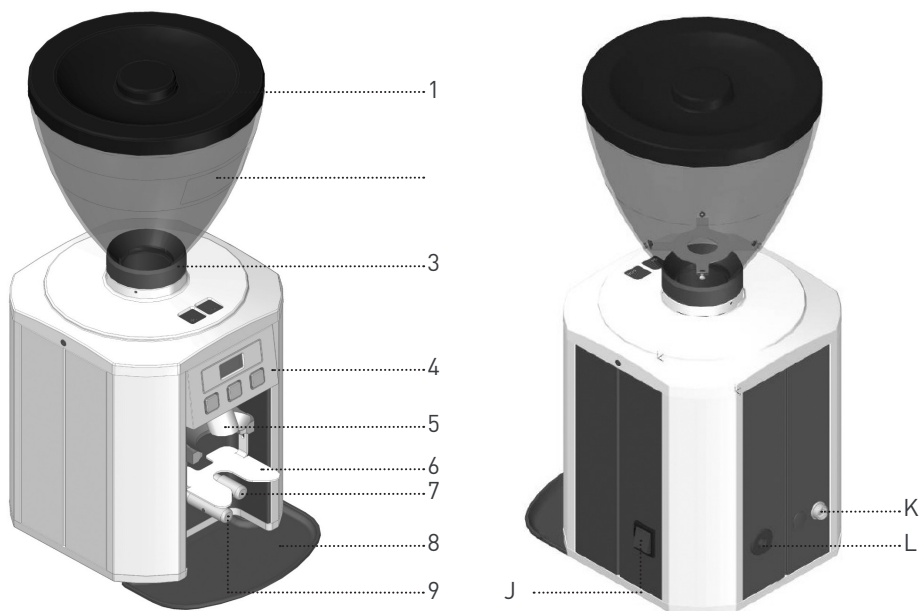

- 1 Coperchio
- 2 Tramoggia caffè
- 3 Vite blocco campana
- 4 Pannello comandi
- 5 Uscita caffè
- 6 Supporto portafiltra

- 7 Tastatore dose singola
- 8 Piattino raccogli caffè
- 9 Tastatore dose doppia
- J Interruttore generale
- K Connettore seriale RS232
- L Cavo di alimentazione

Descrizione frontale comandi

Fig. 2

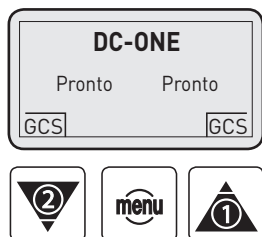

Pulsanti di scorrimento e selezione alto/basso





Pulsante di conferma, accesso impostazioni

Messa in funzione del macinacaffè

Accendere l'interruttore generale dell'apparecchio (Fig. 1). Quando sul display appare la scritta come da schema qui sotto, il macinacaffè è pronto.

Il dc one offre due modalità di macinazione che possono essere impostate dall'installatore durante la fase di set-up del macinacaffè.

Modalità 1

- Premendo  per una dose di caffè.
- Premendo  per dose doppia di caffè.

Modalità 2

Quando il portafiltro è inserito nell'apposito supporto, il dc one riconosce automaticamente la dose da erogare. In questa modalità, se il portafiltro è tolto dal supporto prima del termine dell'erogazione del caffè macinato, l'erogazione s'interrompe mantenendo in memoria il tempo residuo di macinazione (il pulsante della dose interrotta lampeggia per promemoria).

Se si desidera annullare il tempo residuo, sarà sufficiente premere il pulsante lampeggiante.

Regolazioni

Per entrare nel menù principale al fine di visualizzare dati o modificare parametri d'impostazione del macinacaffè dc one è sufficiente premere per 3 secondi il pulsante .

Schema di flusso dei menù

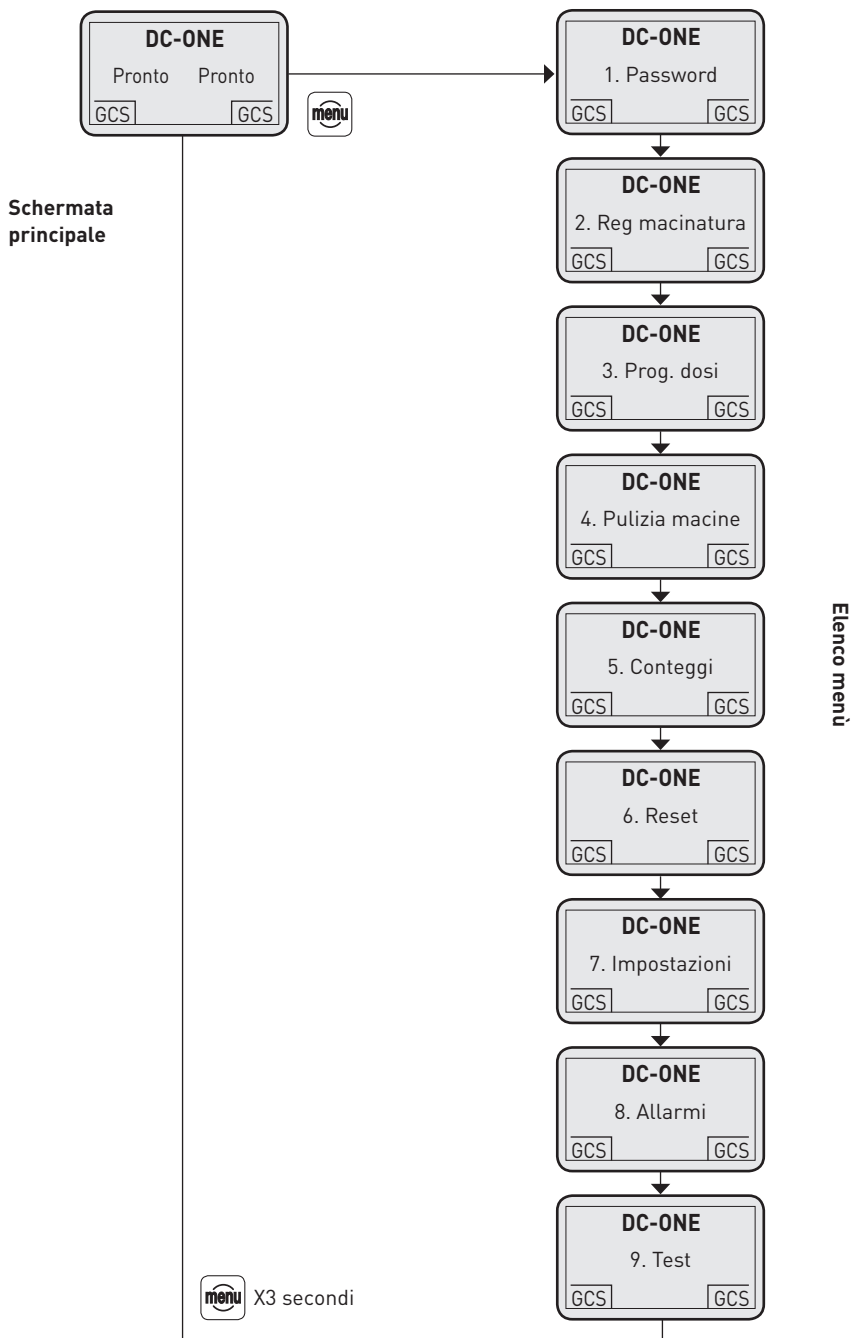

1. Password (PW)

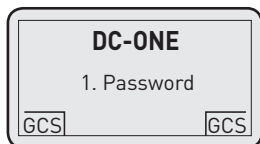

Premendo il pulsante  si visualizza:

1.1 - Inserisci

1.2 - Modifica



Tramite  o  evidenziare la voce INSERISCI e premere  per entrare. Verrà visualizzato:

1.1.1 - User

1.1.2 - Service

Tramite  o  evidenziare la voce USER e premere  per entrare. Verrà visualizzato:



Inserisci 0000

Per inserire la PW utilizzare i pulsanti  o  e al raggiungimento della cifra desiderata premere .

NOTA

In caso d'inserimento errato della PW ripetere nuovamente l'operazione.

Al termine dell'inserimento dell'ultima cifra, premere  per confermarla e tornare all'elenco menù.

Tramite  o  è possibile scorrere la lista degli altri menù, mentre premendo  per 3 secondi si torna alla schermata principale.

Inserendo la PW dello USER, quest'ultimo potrà accedere ad alcuni menù d'impostazione.

La PW di default è 0000.

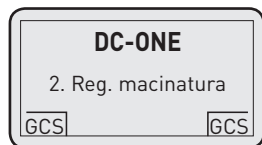

2. Regolazione macinatura



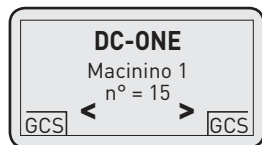

(accessibile dall'utilizzatore con la PW se il sistema GCS è disattivato)

Premendo il pulsante  si visualizza:



Tramite  o  è possibile modificare la granulometria del caffè macinato.

Premendo il pulsante  si torna all'elenco menù.

Tramite  o  è possibile scorrere la lista degli altri menù; premendo invece  per 3 secondi si torna alla schermata principale.

NOTA

Durante la messa a punto della macinatura è possibile prelevare le dosi di caffè macinato senza dover uscire dal menù di regolazione. Questo permette di velocizzare il processo di regolazione del macinacaffè.

3. Programmazione dosi

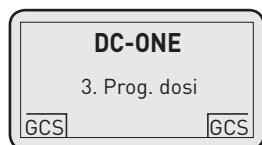

(accessibile dall'utilizzatore con la PW se il sistema GCS è disattivato)

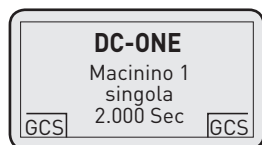

Premendo il pulsante  si visualizza:





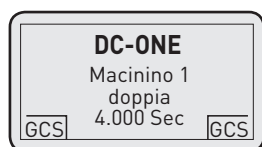

Tramite  o  è possibile modificare il tempo di macinazione (quindi la quantità) della dose singola.

Premendo il pulsante  si conferma e si passa al dato successivo:



Tramite  o  è possibile modificare il tempo di macinazione (quindi la quantità) della dose doppia.

Premendo il pulsante  si conferma il dato e si torna al menù precedente.

Tramite  o  è possibile scorrere la lista degli altri menù, mentre premendo  per 3 secondi si torna alla schermata principale.

4. Pulizia macine

(accessibile dall'utilizzatore senza PW)

Questa funzione permette all'utilizzatore di effettuare un ciclo di pulizia periodico della camera di macinazione (si consiglia una pulizia settimanale).

Questo ciclo di pulizia deve essere eseguito con un apposito prodotto pulente acquistato esclusivamente dall'installatore del macinacaffè. Rimuovere tutto il caffè in grani dalla tramoggia.

Premendo il pulsante  si visualizza:

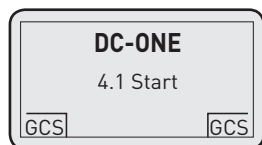

Premendo il pulsante  si visualizza:

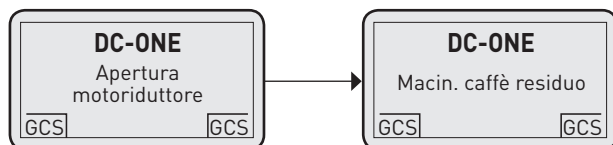

Se si desidera utilizzare il caffè residuo macinato, raccogliero in un contenitore alimentare.

Subito dopo la macinazione del caffè residuo il display visualizzerà:

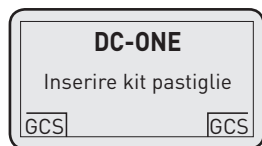

Inserire il prodotto pulente nella tramoggia.

Premendo il pulsante  si visualizza:

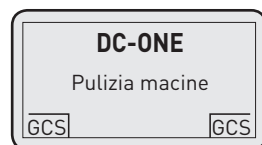

Durante questa fase raccogliere il prodotto pulente macinato e gettarlo nei rifiuti organici.

Al termine del ciclo di pulizia si visualizza:

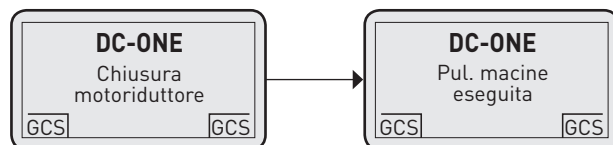

Premendo il pulsante  per 3 secondi si torna alla schermata principale.

5. Conteggi

(accessibile dall'utilizzatore senza PW)

Questa funzione serve a visualizzare tutti i contatori di caffè.

Premendo il pulsante  si visualizza:

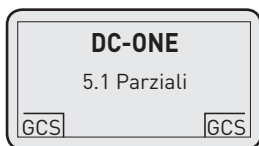

Tramite  o  evidenziare la voce desiderata e premere  per entrare.

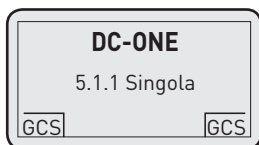

Premendo il pulsante  si visualizza:

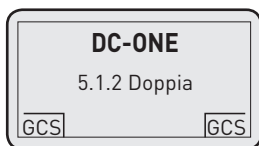
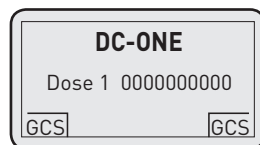

Premendo il pulsante  si visualizza:

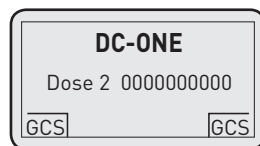

Tramite  o  evidenziare la voce desiderata e premere  per entrare.

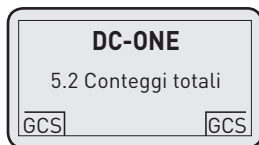

Tramite  o  evidenziare la voce desiderata e premere  per entrare.

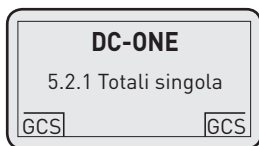

Premendo il pulsante  si visualizza:

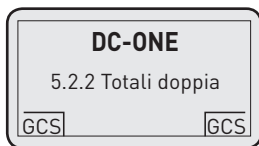
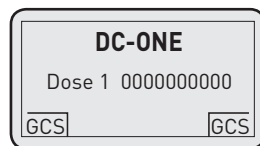

Premendo il pulsante  si visualizza:

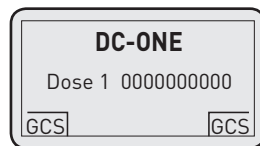

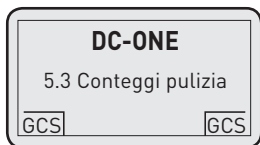

Premendo il pulsante  per 3 secondi si torna al menù 5. Conteggi.

Tramite  o  evidenziare la voce desiderata e premere  per entrare.

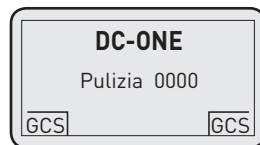

Premendo il pulsante  si visualizza:



Premendo il pulsante  per 3 secondi si torna all'elenco menù.

6. Reset

(accessibile dall'utilizzatore con la PW, solo 6.2)

Questa funzione permette all'utilizzatore di azzerare i contatori di caffè parziali.

Tramite  o  evidenziare la voce desiderata e premere  per entrare.

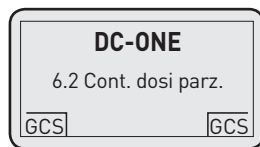

Premendo il pulsante  si visualizza:

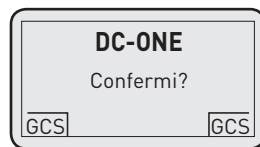

Premendo il pulsante  si visualizza:

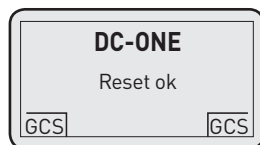

Premendo il pulsante  per 3 secondi si torna all'elenco menù.

7. Impostazioni

(accessibile solo dal service)

Questo menù serve ad accedere a tutte le impostazioni del macinacaffè.





8. Allarmi

(accessibile dall'utilizzatore senza PW)

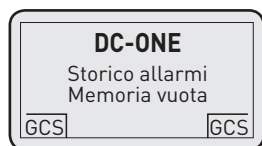
In questo menù è possibile visualizzare lo storico allarmi presente nella memoria del macinacaffè (è possibile visualizzare fino a un max. di 50 allarmi).

Premendo il pulsante  si visualizza:



Tramite  o  è possibile visualizzare tutti gli allarmi eventualmente presenti nella memoria del macinacaffè. Premere il pulsante  per tornare all'elenco menù oppure  per 3 secondi per tornare alla schermata principale.

9. Test

(accessibile solo dal service)

Manutenzione ordinaria

Per manutenzione ordinaria s'intende la pulizia interna che deve essere eseguita ogni settimana con l'apposito prodotto commercializzato dal costruttore per la pulizia delle macine e della camera di macinazione (quindi tutte le parti a contatto con il caffè) attraverso il ciclo di pulizia sopramenzionato "4. Pulizia macine".

Per la pulizia giornaliera esterna è invece necessario

utilizzare un prodotto sgrassante ma non solvente, inodore e idoneo alla pulizia di superfici che entrano a contatto con alimenti.

Non utilizzare spugne abrasive per evitare di rovinare le parti esterne.

L'interno della tramoggia del caffè in grani va pulito settimanalmente, sempre con l'apposito detergente.

ATTENZIONE

In caso il macinacaffè non venga utilizzato per qualche giorno, eseguire un ciclo di pulizia delle macine prima di riutilizzarlo per evitare che residui di caffè vecchio influiscano negativamente sul sapore del caffè macinato fresco.

Allarmi

Questo macinacaffè ha un controllo elettronico che permette di verificare e segnalare una serie di possibili anomalie causate da un guasto di una parte interna o da un non corretto utilizzo dell'apparecchio stesso.

Alcuni di questi allarmi sono solo di segnalazione, altri invece attivano il blocco del macinacaffè.

Nel caso si presenti un allarme, procedere come segue:

ALLARME	CAUSA	SOLUZIONE
Perdita dati	Grossa interferenza sulla rete elettrica	Spegnere e riaccendere il macinacaffè per lavorare. Chiamare un tecnico autorizzato
Macina bloccata	Impurità di dimensioni importanti nel caffè	Procedere con ciclo di pulizia macine. Se il problema persiste, chiamare un tecnico autorizzato
Linea seriale guasta	Macchina da caffè spenta o cavo seriale scollegato	Spegnere e riaccendere il macinacaffè per lavorare. Chiamare un tecnico autorizzato
Triac guasto	Problema al motore di macinazione	Spegnere e riaccendere il macinacaffè per lavorare. Chiamare un tecnico autorizzato
Bassa tensione	Problemi di tensione di alimentazione	Spegnere e riaccendere il macinacaffè per lavorare. Chiamare un tecnico autorizzato
Pulizia macine	Necessità di ciclo di pulizia	Eseguire il ciclo di pulizia macine
Alta temperatura interna	Surriscaldamento del motore e/o ventilazione bloccata	Spegnere e riaccendere il macinacaffè per lavorare e chiamare il tecnico
Alta temperatura caffè	Macine consumate	Spegnere e riaccendere il macinacaffè per lavorare. Chiamare un tecnico autorizzato
Blocco motoriduttore	Motoriduttore per la regolazione della macinatura bloccato	Spegnere e riaccendere il macinacaffè per lavorare. Chiamare un tecnico autorizzato
Sensore hall guasto	Sensore di posizione delle macine guasto	Spegnere e riaccendere il macinacaffè per lavorare. Chiamare un tecnico autorizzato
Sonda NTC guasta	Sensore di temperatura del motore guasto	Spegnere e riaccendere il macinacaffè per lavorare. Chiamare un tecnico autorizzato
Sonda Pt1000 guasta	Sensore di temperatura del caffè guasto	Spegnere e riaccendere il macinacaffè per lavorare. Chiamare un tecnico autorizzato



2.0

USER MANUAL

Congratulations for purchasing this espresso coffee grinder

This espresso coffee grinder combines several innovative features, such as a revolutionary technology, an ergonomic design, the highest quality standard in materials and an extreme easiness of use.

This manual is structured in order to be a useful tool for gaining a good knowledge of the machine and its use. It contains all the important information related to machine functioning, technical details, operating instructions and correct maintenance. High-level performances can be obtained by reading this manual – just follow the instructions carefully and take your time to discover your new espresso coffee grinder in all its details.

Coffee grinder accessories

- User manual
- Cleaning brush
- Ground coffee container
- Product for internal cleaning (sample for one cleaning cycle)

General notes

WARNING

The appliance must be destined exclusively to the use it has been made for. Any other use shall be considered improper and therefore unreasonable. The manufacturer cannot be held responsible for any damages caused by improper, wrong or unreasonable use. The appliance must be used by qualified personnel only.

The instructions and warnings of this manual shall be read carefully, since they provide important information on the use and functioning of the appliance.

If power cable needs to be replaced, replace it with a cable suggested by the manufacturer.

The electric safety of the appliance is achieved only when the appliance is correctly **connected to a grounded electric system**.

This fundamental requirement shall be assessed by qualified personnel. Manufacturer and installer cannot be held responsible for any possible damages caused by the lack or inefficiency of system grounding.

Some fundamental rules shall be followed when using any electric appliance:

- do not use the appliance with wet hands / feet or barefoot.
- The appliance shall not be used by persons (children included) with reduced physical, sense or mental faculties, or lacking experience / knowledge, unless they are provided with surveillance

or appliance instructions by a person responsible for their safety.

- Unplug the appliance from the electric system before carrying out any cleaning and ordinary maintenance.
- To clean the appliance, do not put it under a jet of water, nor plunge it into the water.
- Do not leave the appliance switched-on and unattended for long periods (e.g. 1 day).
- In order to ensure the efficiency and correct functioning of the appliance, it is necessary to follow the instructions provided by the manufacturer and to carry out the ordinary maintenance.
- The temperature of the environment surrounding the appliance must be between 5° and 35°C.

In case the appliance is temporarily placed in an environment where the temperature is below 0°C, contact a local Technical Service authorised by the manufacturer.

- In case of appliance breakdown and/or malfunctioning, switch it off and refrain from trying to repair it. Consult a local Technical Service that has been authorised by the manufacturer.

GCS (GRINDER CONTROL SYSTEM)

This coffee grinder is equipped with an electronic control system for the digital programming of grinding time and grind fineness. Moreover, it can be adjusted automatically by connecting it to Dalla Corte evo2 or Ddc pro coffee machines through a serial cable.

This system controls and adjusts coffee grind fineness by means of the espresso machine. The machine monitors every coffee extraction: if extraction parameters do not correspond to the set ones, it sends the coffee grinder an order to modify grind fineness and grinding time.

Setting up for installation

WARNING

The installation must be carried out in compliance with laws in force, following the manufacturer's instructions and by qualified professionals only. A wrong installation of the appliance can damage people, animals and things. The manufacturer cannot be held responsible for damages caused by a wrong installation.

The appliance shall be installed next to the coffee machine on a stable and safe bearing surface (30 x 40 cm) and a minimum clearance of 70 cm shall be left above it. A 10-16 amp, single-phase power socket compliant with local laws must also be present.

After unpacking the appliance, check it is undamaged and that no parts are missing. If you are in any doubt, do not use it.

Packing elements shall never be left within reach of children, since they are potentially dangerous. Before plugging the appliance into the electric system, check that technical data on the identification plate match with those of the installation place.

In case it is necessary to change the appliance power cable, consult the appliance installer.



General description and starting instructions

Pic. 1

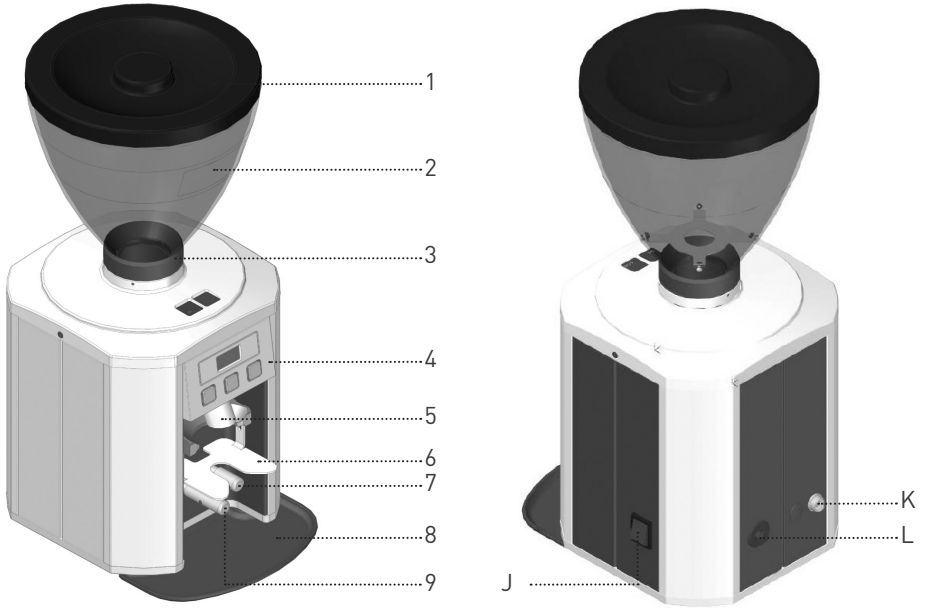



- 1 Whole bean hopper lid
- 2 Whole bean hopper
- 3 Hopper safety screw
- 4 Control panel
- 5 Coffee exit
- 6 Filter holder support

- 7 Single dose dial indicator
- 8 Coffee spill tray
- 9 Double dose dial indicator
- J ON/OFF Switch
- K Connettore seriale RS232
- L Power Socket

Control panel description

Pic. 2



-   Scroll and selection button up/down
-  Confirmation button, access to settings



Starting the grinder

Switch on the appliance with the ON/OFF switch (Pic.1).

When the display shows the notice contained in the flow chart below, the coffee grinder is ready.

dc one can be operated in 2 modes, which can be set by the installer during the set-up stage;

Mode 1

- Press  to obtain 1 coffee dose (Single Shot)
- Press  to obtain 2 coffee doses (Double Shot)

Mode 2

If the filter holder is attached to its support, dc one automatically recognises which dose to supply.

In this mode, if the filter holder is removed from its support before the grinding ends, the ground coffee supply stops and the remaining grinding time is kept in memory (the button of the interrupted dose blinks as a reminder).

To cancel the remaining grinding time, just press the blinking button.

Settings and adjustments

If you want to access the main menu to get information or modify dc one grinder setting parameters, press the  button for 3 seconds.

Menus flow chart

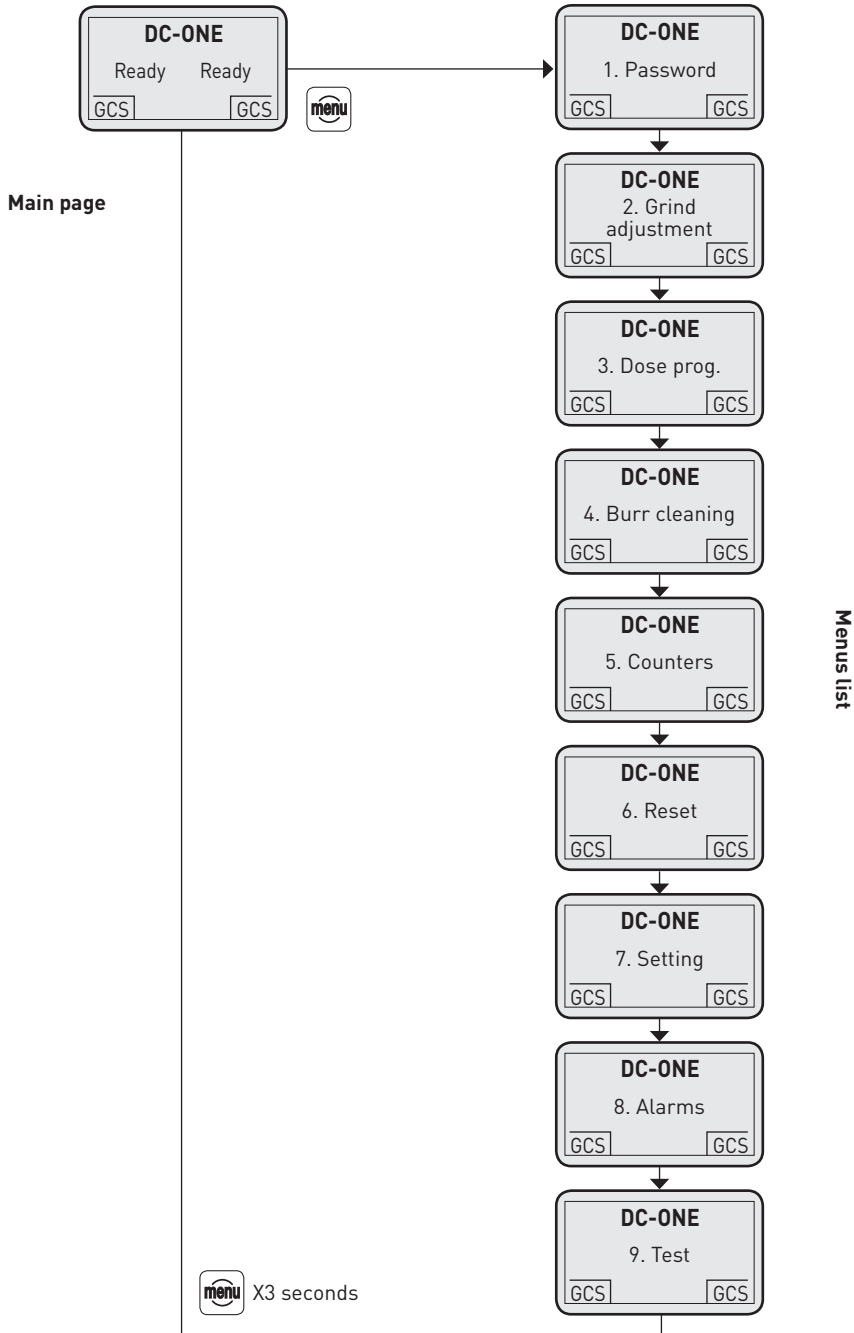

1. Password (PW)

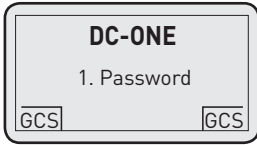

If you press the  button, the following items are displayed:



1.1 - Enter

1.2 - Modify

Use  or  to select the ENTER item and press  to enter. The display will show:

1.1.1 - User

1.1.2 - Service

Use  or  to select the USER item and press  to enter. The display will show:



Enter 0000

To enter PW, use  or  buttons – when the desired digit is displayed, press .

NOTE

If the wrong PW is entered, restart the PW entering procedure.

After the last digit has been entered, press  to confirm it and to go back to the menu list.

The menu list can be scrolled by using  or . Just press  for 3 seconds if you wish to go back to main page.

By entering the USER PW, the user can access some set-up menus.

The default USER PW is 0000.

2. Grind adjustment

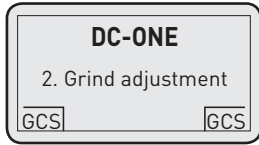



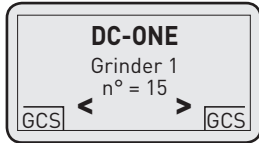

(accessible by the user by entering the PW, if GCS is not in function)

If you press the  button, the display will show:



Press the  or  buttons to modify grind fineness.

Press the  button to go back to the menu list.

Use the  or  buttons to scroll the menu list; if you want to go back to the main page, just press  for 3 seconds.

NOTE

During coffee grind adjustment, ground coffee doses can still be poured without quitting the menu – this quickens coffee grinder adjustment.

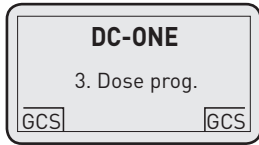

3. Dose programming





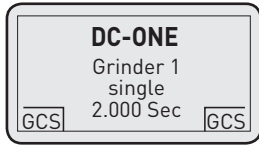

(accessible by the user by entering the PW, if GCS is not in function)

If you press the  button, the display will show:

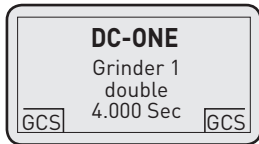

Use the  or  buttons to modify the grinding time (and therefore the quantity) of the single dose. Press the  button to confirm and pass to the next setting:



Use the  or  buttons to modify the grinding time (and therefore the quantity) of the double dose. Press the  button to confirm the setting and go back to the previous menu.

Press  or  to scroll the menu list or press  for 3 seconds to go back to the main page.

4. Burr cleaning

(accessible by the user - no PW needed)

This function allows the user to start a periodic cleaning cycle of the grinding chamber (a weekly cleaning is suggested). This cleaning cycle must be carried out with a suitable cleaning product purchased exclusively from the coffee grinder installer.

Remove all coffee beans from the hopper.

If you press the  button, the display will show:

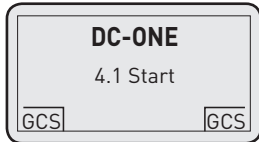

If you press the  button, the display will show:

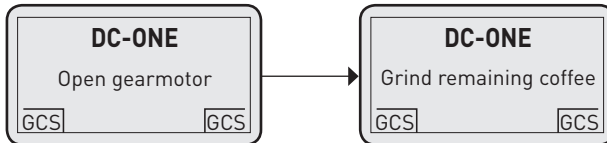

Collect the remaining ground coffee into a food container.

Right after the remaining coffee has been ground, the display will show:

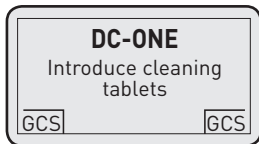

Put the cleaning product in the hopper.

If you press the  button, the display will show:

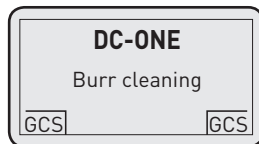

During this phase, collect the ground cleaning product and throw it in organic waste bin.

At the end of the cleaning cycle, the display will show:

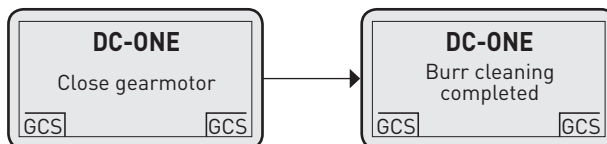

Press the  button for 3 seconds to go back to the main page.



5. Counters

[accessible by the user - no PW needed]

This function is used to display all coffee dose counters.

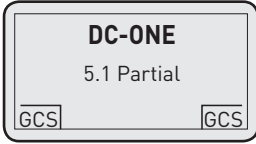
If you press the  button, the display will show:



Use  or  to select the desired menu item and press  to enter.

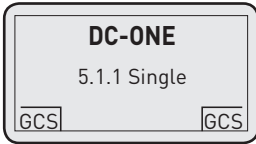

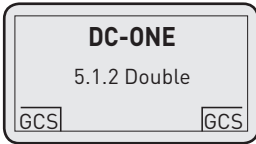
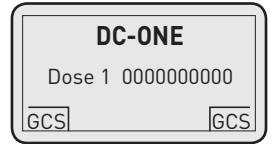

If you press the  button, the display will show:



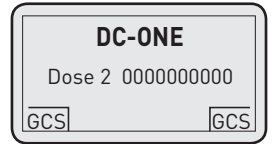



If you press the  button, the display will show:

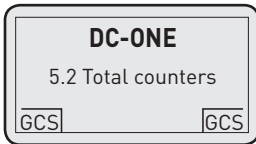

Press the  button for 3 seconds to go back to menu 5- counters.

Use  or  to select the desired menu item and press  to enter.



Use  or  to select the desired menu item and press  to enter.

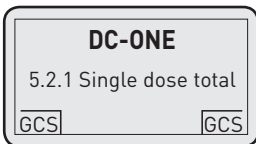



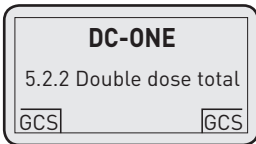
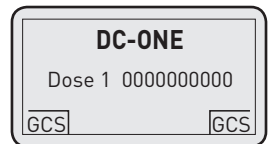

If you press the  button, the display will show:

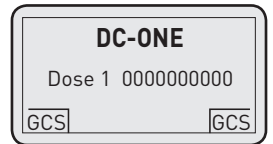

If you press the  button, the display will show:



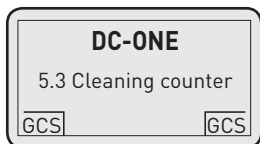

Press the  button for 3 seconds to go back to menu 5. Counters.

Use  or  to select the desired menu item and press  to enter.

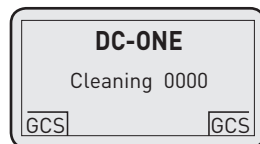

If you press the  button, the display will show:





Press the  button for 3 seconds to go back to the menu list.

6. Reset

(accessible by the user by entering the PW - item 6.2 only)

This function enables the user to reset the partial coffee dose counters.

Use  or  to select the desired menu item and press  to enter.

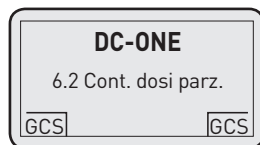

If you press the  button, the display will show:

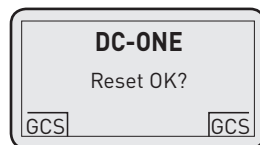

If you press the  button, the display will show:

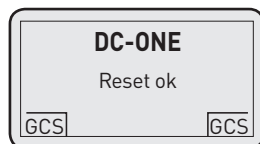

Press the  button for 3 seconds to go back to the menu list.

7. Settings menu

[accessible by service only]

This menu is used for coffee grinder set-up.



8. Alarms

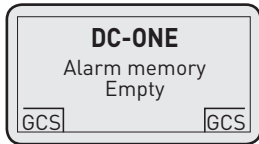

[accessible by the user - no PW needed]

This menu contains the list of alarms that have been stored in the grinder memory (a maximum of 50 alarms can be displayed).

If you press the  button, the following data are displayed:



Use the  or  buttons to display all the alarms stored in the coffee grinder memory.

Press the  button to go back to the menu list or  for 3 seconds to go back to the main page.

9. Test

[accessible by service only]

Ordinary maintenance

Ordinary maintenance refers to the appliance internal cleaning that must be performed every week through the above mentioned cleaning cycle "4. Burr cleaning". It must be carried out with a product that is specially sold by the manufacturer for the cleaning of burrs and grinding chamber (and therefore all the parts that come in contact with coffee).

Conversely, the daily external cleaning of the appliance requires a product that is degreasing (but not a solvent), odourless and suitable for surfaces that come in contact with food.

To avoid ruining external parts, do not use abrasive sponges.

Clean the internal part of the whole bean hopper with the special detergent on a weekly base.

WARNING

In case the coffee grinder remains unused for some days, perform a cleaning cycle before using it again in order to prevent old coffee remains from affecting the taste of the freshly ground coffee.

Alarm

This coffee grinder has an electronic control that checks and signals a series of possible anomalies due to failures of internal parts or to incorrect use.

Some of the alarms are designed only to signal possible failures, others can lock the coffee grinder. In case an alarm is triggered, do as follows.

ALARM	CAUSE	SOLUTION
Data loss	Big interference on the electric network	Switch off the grinder, then switch it on again to go on with work. Contact the technical service
Blocked burr	Coffee contains impurities of significant dimensions	Try the burr cleaning cycle or contact the technical service
Broken serial line	Coffee machine is switched off or serial cord is unplugged	Switch off the grinder, then switch it on again to go on with work. Contact the technical service
Triac board not working	Failure in grinding motor	Switch off the grinder, then switch it on again to go on with work. Contact the technical service
Low tension	Power supply tension problems	Switch off the grinder, then switch it on again to go on with work. Contact the technical service
Burr cleaning	A cleaning cycle is necessary	Start the burr cleaning cycle
High internal temperature	Motor is overheated and/or air cooling is blocked	Switch off the grinder, then switch it on again to go on with work. Contact the technical service
High coffee temperature	Worn out burrs	Switch off the grinder, then switch it on again to go on with work. Contact the technical service
Blocked gearmotor	Gearmotor for grind adjustment is blocked	Switch off the grinder, then switch it on again to go on with work. Contact the technical service
Broken hall sensor	Sensor of burrs position is broken	Switch off the grinder, then switch it on again to go on with work. Contact the technical service
Broken NTC probe	Motor temperature sensor is broken	Switch off the grinder, then switch it on again to go on with work. Contact the technical service
Broken Pt1000 probe	Coffee temperature sensor is broken	Switch off the grinder, then switch it on again to go on with work. Contact the technical service



3.0

BENUTZERHANDBUCH

Herzlichen glückwunsch zum kauf dieser mühle

Wir vereinen in unseren Produkten eine revolutionäre Technologie, ergonomisches Design, höchsten Qualitätsstandard in der Materialauswahl sowie einen faszinierenden Bedienungskomfort.

Dalla Corte steht für Innovation. Diese Bedienungsanleitung soll Ihnen dabei helfen, die Mühle kennenzulernen und sie somit optimal einsetzen zu können. Sie enthält alle wichtigen Informationen zu Mühlenfunktionen und deren Bedienung, zu technischen Details und Pflegehinweisen.

Lesen Sie diese Anleitung sorgfältig und lernen Sie ihre neue Dalla Corte in all ihren Details besser kennen. Viel Spaß bei der Entdeckung des "proof of taste"!

Zubehör

- Bedienungsanleitung
- Reinigungsbürste
- Behälter für gemahlene Kaffeebohnen
- Reinigungsmittel (Musterpackung für eine Reinigung)

Allgemeine Hinweise

ACHTUNG

Dieses Gerät darf nur für professionellen Bestimmungszweck verwendet werden, für den es konzipiert wurde. Jede weitere Verwendungsweise ist als missbräuchlich und folglich als unangemessen zu betrachten. Der Hersteller kann nicht für etwaige Schäden zur Verantwortung gezogen werden, die sich aus einer missbräuchlichen, unsachgemäßen und unangemessen Anwendung ergeben.

Die Anweisungen und Warnhinweise dieser Anleitung müssen sorgfältig durchgelesen werden, da sie wichtige Informationen über die Verwendung und die Funktion des Geräts enthalten. **Falls elektrische Kabel ersetzt werden müssen, verwenden Sie die vom Hersteller empfohlenen Kabel.**

Die elektrische Sicherheit des Geräts ist nur gewährleistet, wenn das Gerät in korrekter Weise an ein **Erdungssystem angeschlossen ist**.

Diese grundlegende Anforderung muss von einem Fachmann überprüft werden. Der Hersteller und der Monteur können nicht für mögliche Schäden verantwortlich gemacht werden, die durch mangelnde Effizienz des Erdungssystems hervorgerufen werden.

Die Verwendung eines elektrischen Geräts setzt die Einhaltung einiger grundlegender Regeln voraus.

- Benutzen Sie das Gerät nicht mit nassen Händen/Füßen oder barfuß.
- Das Gerät darf nicht von Personen mit verringerten physischen, verstandesmäßigen oder geistigen Fähigkeiten oder mangelnder Erfahrung oder Kenntnis benutzt werden, es sei denn, sie werden

beaufsichtigt oder erhalten Anweisungen über das Gerät von einer Person, die für ihre Sicherheit verantwortlich ist.

- Das Gerät muss vom elektrischen System getrennt werden, bevor Reinigungs- oder planmäßige Wartungsarbeiten durchgeführt werden.
- Zur Reinigung darf das Gerät nicht mit Wasser bespritzt oder in Wasser getaucht werden.
- Das Gerät darf nicht für längere Zeiträume eingeschaltet und dabei unbeaufsichtigt bleiben (z.B. 1 Tag).
- Um eine effiziente und korrekte Funktionsweise des Geräts sicherzustellen, ist es notwendig, dass die Anweisungen des Herstellers befolgt und planmäßige Wartungsarbeiten durchgeführt werden.
- Die Umgebungstemperatur des Geräts muss zwischen 5° und 35°C betragen.
- Falls sich das Gerät zeitweise in einer Umgebungstemperatur von unter 0°C befindet, wenden Sie sich bitte an einen vom Hersteller autorisierten technischen Service.
- Falls das Gerät ausfällt und/oder eine Funktionsstörung aufweist, versuchen Sie nicht es zu reparieren. Wenden Sie sich bitte an einen vom Hersteller autorisierten technischen Service vor Ort.

GCS (GRINDER CONTROL SYSTEM)

Diese Kaffeemühle ist mit einem elektronischen Steuersystem zur digitalen Programmierung der Mahldauer und des Mahlgrads ausgestattet. Außerdem kann sie durch Anschluss mit einem seriellen Kabel an die Dalla Corte evo2 oder dc pro Kaffeemaschine automatisch eingestellt werden.

In diesem System wird der Mahlgrad durch die Espressomaschine gesteuert und eingestellt. Das Gerät überwacht jede Kaffeeextraktion: Falls die Extraktionsparameter nicht den eingestellten Werten entsprechen, sendet sie der Kaffeemühle das Signal zur Änderung des Mahlgrads und der Mahldauer.

Installationsanweisungen

ACHTUNG

Die Installation muss gemäß gültigen Gesetzen und den Anweisungen des Herstellers nur von qualifizierten Fachleuten durchgeführt werden. Eine falsche Installation kann Menschen, Tieren und Vermögensgegenständen Schaden zufügen. Der Hersteller kann nicht für Schäden verantwortlich gemacht werden, die aus einer falschen Installation resultieren.

Das Gerät wird neben der Kaffeemaschine auf einer stabilen und sicheren Tragfläche (30 x 40 cm) installiert. Der Freiraum über dem Gerät beträgt mindestens 70 cm. Eine den örtlichen Vorschriften entsprechende 10-16 amp einphasige Steckdose wird ebenfalls benötigt.

Nachdem das Gerät ausgepackt worden ist, prüfen Sie es auf Unversehrtheit und eventuell fehlende Teile. Falls Sie irgendwelche Zweifel haben, verwenden Sie das Gerät nicht.

Teile der Verpackung dürfen nie in Reichweite von Kindern zurückgelassen werden, da sie ein Gefahrenpotential beinhalten.

Bevor Sie den Stecker des Geräts einstecken, prüfen Sie, ob die technischen Daten auf dem Typenschild mit denen des Installationsorts übereinstimmen.

Falls das elektrische Kabel des Geräts ausgetauscht werden muss, wenden Sie sich an den Installateur des Geräts.



Allgemeine beschreibung und inbetriebnahme der kaffeemühle

Abb. 1

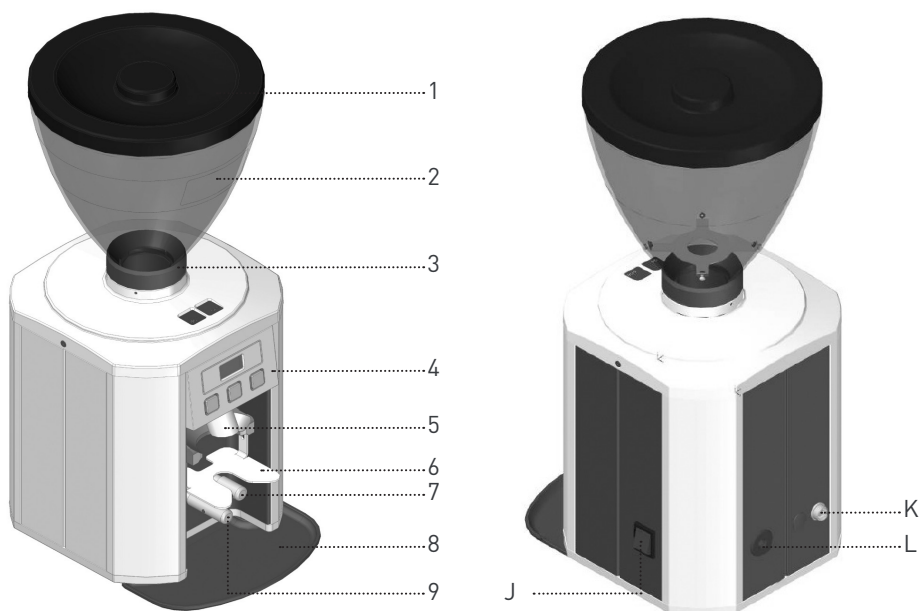

- 1 Deckel des Bohnenbehälters für ganze Bohnen
- 2 Bohnenbehälter für ganze Bohnen
- 3 Sicherheitsschraube des Bohnenbehälters
- 4 Bedienfeld
- 5 Kaffeeaustritt
- 6 Siebträgerhalterung

- 7 Einzeldosierungserkennung
- 8 Kaffeeauffangschale
- 9 Doppeldosierungserkennung
- J I/O Schalter
- K RS232 serielle Verbindung
- L Steckdose

Beschreibung der befehle stirnseite

Abb. 2

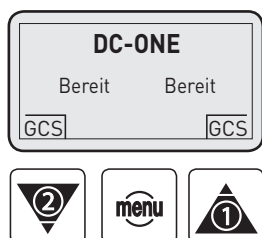

Auswahlmenü
auf/ab





Bestätigungstaster,
Zugriff auf Einstellungen

Inbetriebnahme der Kaffeemühle

Schalten Sie das Gerät am I/O-Schalter ein (Abb. 1). Wenn "Bereit" im Display erscheint, ist die Kaffeemühle betriebsbereit.

Die dc one kann in 2 Betriebsarten arbeiten, die der Installateur bei der Einrichtung des Geräts einstellen kann:

Betriebsart 1 (manuelle Dosierung)

- Drücken Sie  für 1 Kaffeedosierung (Single Shot).
- Drücken Sie  für 2 Kaffeedosierungen (Double Shot).

Betriebsart 2 (automatische Dosierung)

Nachdem der Siebträger in die Halterung eingeführt worden ist, erkennt dc one automatisch die entsprechende Dosierung für den Single- oder Double Shot Siebträger.

Wenn der Siebträger in dieser Betriebsart vor Ende des Mahlvorgangs aus der Halterung genommen wird, bricht das Gerät die Mahlung ab und speichert die verbleibende Zeit des Mahlvorgangs (die Taste der unterbrochenen Dosierung blinkt zur Erinnerung). Drücken Sie einfach die blinkende Taste, um die verbliebene Mahlzeit zu löschen.

Einstellungen und regulierung

Wenn Sie Einstellungen auslesen oder die Parameter der dc one ändern möchten, drücken Sie die  Taste 3 Sekunden lang und erhalten damit den Zugang zum Hauptmenü.

Flussschema der menüs

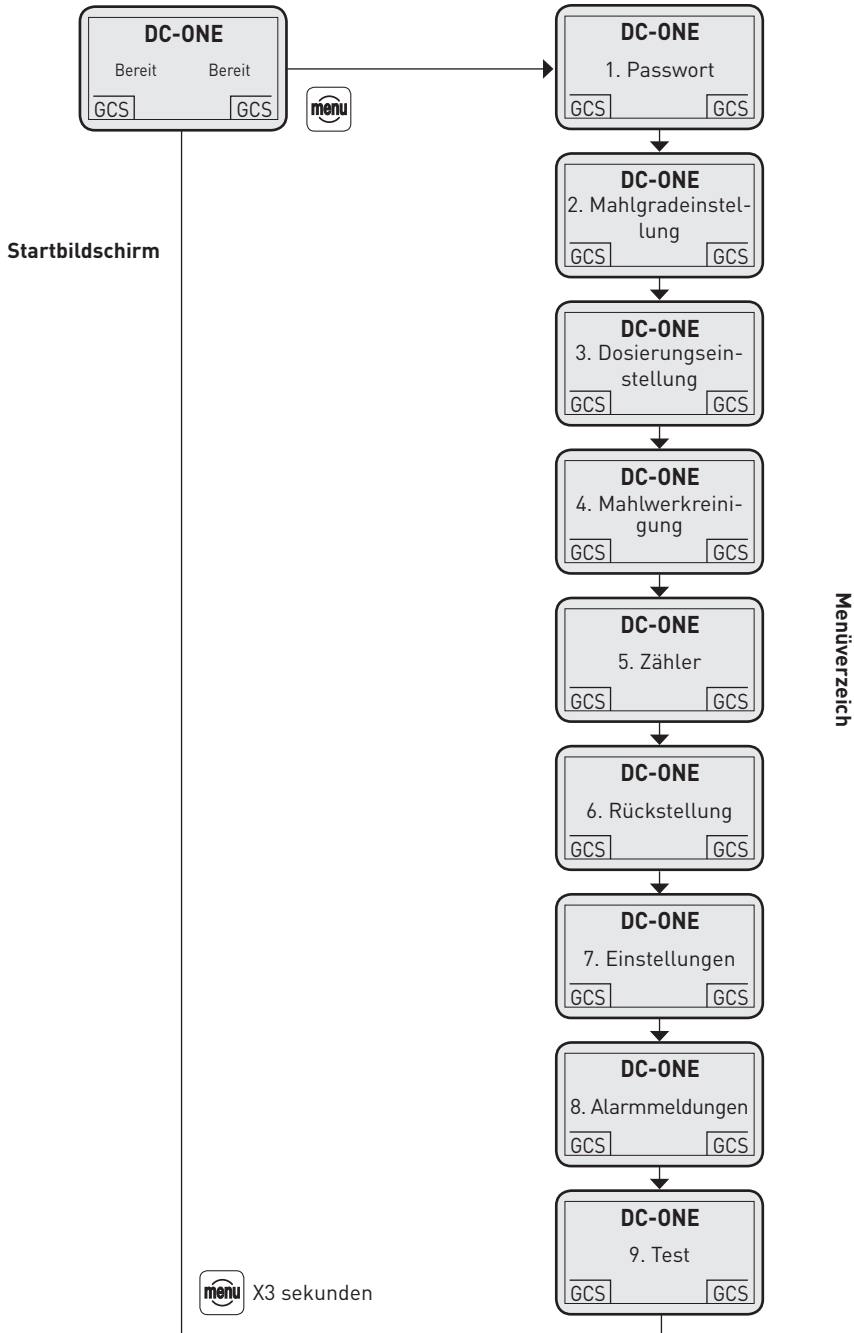

1. Passwort (PW)

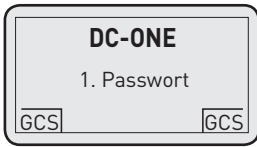







Wenn Sie die die  drücken, erscheinen die folgenden Optionen:

- 1.1 - Eingabe
- 1.2 - Änderung





Wählen Sie EINGABE mit der  oder  Taste und drücken Sie auf  Das Display zeigt:

- 1.1.1 - Benutzer
- 1.1.2 - Service

Wählen Sie BENUTZER mit der  oder  Taste und drücken Sie auf  Das Display zeigt: Eingabe 0000
Zur Eingabe des PW, benutzen Sie die  oder  Taste - wenn die gewünschte Ziffer erscheint, drücken Sie auf .

ANMERKUNG

Bei Eingabe eines falschen Passworts beginnen Sie den PW-Eingabevorgang erneut.

Nach Eingabe der letzten Ziffer drücken Sie auf  zur Bestätigung und Rückkehr zum Menü.
Sie navigieren durch die Menüliste mit der  oder  Taste. Wenn Sie zur Hauptseite zurückkehren möchten, drücken Sie  3 Sekunden lang.
Nach Eingabe des BENUTZER-PW, kann der Benutzer auf mehrere Einstellungsmenüs zugreifen.
Das vorgegebene BENUTZER-PW ist 0000.

2. Mahlgradeinstellung

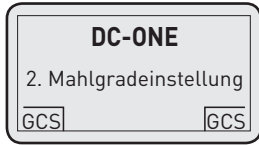

(Zugriffsmöglichkeit für den Benutzer nach Eingabe des PW, falls das Grinder-Control-System nicht aktiviert ist)
Nachdem Sie die  Taste gedrückt haben, erscheint auf dem Display:

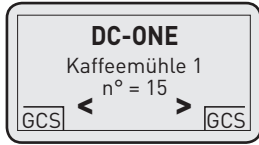

Drücken Sie die  oder  Taste zur Änderung des Mahlgrads.

Drücken Sie die  Taste zur Rückkehr zur Menüliste.

Sie navigieren durch die Menüliste mit der  oder  Taste. Wenn Sie zur Hauptseite zurückgehen möchten, drücken Sie  3 Sekunden lang.

ANMERKUNG

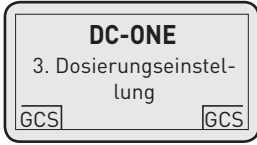

Während der Einstellung des Mahlgrads kann weiterhin gemahlener Kaffee entnommen werden, ohne dass das Menü verlassen werden muss - dies beschleunigt die Einstellung des Mahlgrades.

3. Dosierungseinstellung



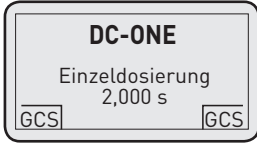



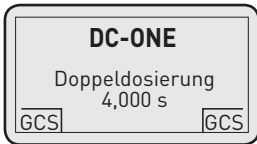

(Zugriffsmöglichkeit für den Benutzer nach Eingabe des PW, falls das Grinder-Control-System nicht aktiviert ist). Nachdem Sie die  Taste gedrückt haben, erscheint auf dem Display:



Ändern Sie die Mahlzeit (und damit die Menge) der Einzeldosierung mit der  oder  Taste. Drücken Sie die  Taste zur Bestätigung und Navigation zur nächsten Einstellung:



Ändern Sie die Mahlzeit (und damit die Menge) der Doppeldosierung mit der  oder  Taste. Drücken Sie die  Taste zur Bestätigung und zur Rückkehr zum vorherigen Menü.

Drücken Sie die  oder  Taste, um durch die Menüliste zu navigieren, oder drücken Sie die  Taste 3 Sekunden lang, um zur Hauptseite zurückzukehren.

4. Mahlwerkreinigung

(Zugriffsmöglichkeit für den Benutzer – ohne PW)

Mit dieser Funktion startet der Benutzer die regelmäßige Reinigung des Mahlwerks (wöchentliche Reinigung wird empfohlen).

Die Reinigung muss mit einem ausschließlich vom Installateur der Kaffemühle erworbenen, geeigneten Reinigungsmittel durchgeführt werden. Entfernen Sie alle Kaffeebohnen aus dem Einfülltrichter.

Nachdem Sie die  Taste gedrückt haben, erscheint auf dem Display:

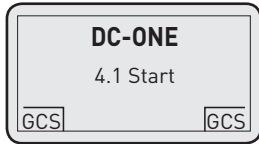

Nachdem Sie die  Taste gedrückt haben, erscheint auf dem Display:

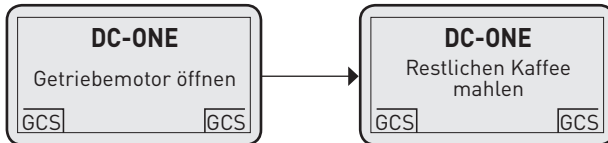

Füllen Sie den verbleibenden Kaffee in einen für Nahrungsmittel geeigneten Behälter.

Sowie der restliche Kaffee gemahlen ist, erscheint auf dem Display:

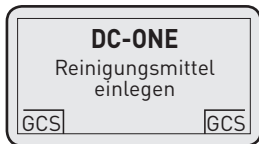

Füllen Sie das Reinigungsmittel in den Bohnenbehälter.

Nachdem Sie die  Taste gedrückt haben, erscheint auf dem Display:

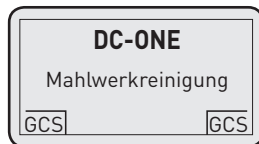

Entnehmen Sie in dieser Phase das gemahlene Reinigungsmittel und entsorgen Sie es im organischen Müll.

Am Ende der Reinigung erscheint auf dem Display:

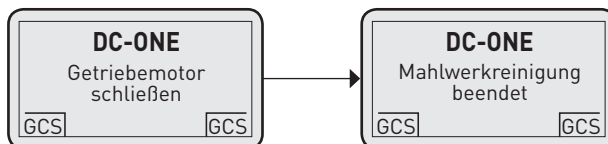

Drücken Sie die  Taste 3 Sekunden lang zur Rückkehr zur Hauptseite.

5. Zähler

(Zugriffsmöglichkeit für den Benutzer – ohne PW)

Mit dieser Funktion werden alle Zähler der Kaffeedosierungen angezeigt.

Nachdem Sie die  Taste gedrückt haben, erscheint auf dem Display:

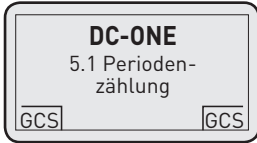

Wählen Sie mit  oder  die gewünschte Menüoption und drücken Sie die  Taste zur Eingabe.

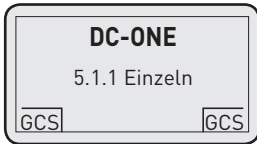

Nachdem Sie die  Taste gedrückt haben, erscheint:

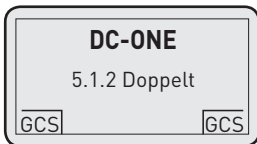
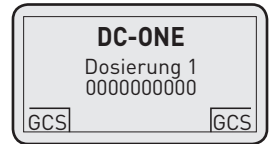

Nachdem Sie die  Taste gedrückt haben, erscheint:

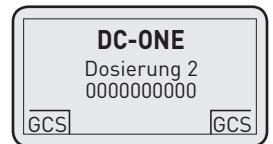

Drücken Sie die  Taste 3 Sekunden lang zur Rückkehr zum Menü 5- Zähler.

Wählen Sie mit  oder  die gewünschte Menüoption und drücken Sie die  Taste zur Eingabe.

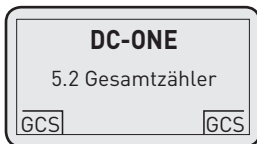

Wählen Sie mit  oder  die gewünschte Menüoption und drücken Sie die  Taste zur Eingabe.

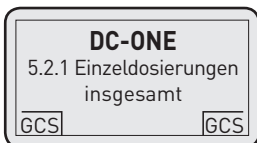

Nachdem Sie die  Taste gedrückt haben, erscheint:

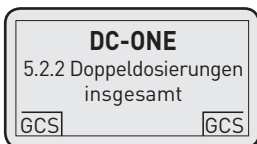
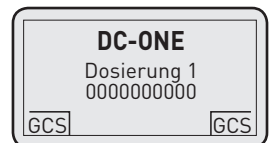

Nachdem Sie die  Taste gedrückt haben, erscheint:

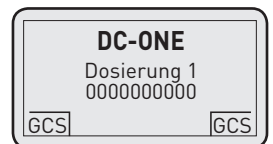

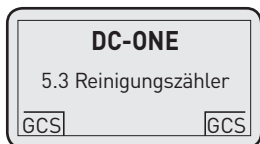

Drücken Sie die  Taste 3 Sekunden lang zur Rückkehr zum Menü 5. Zähler.

Wählen Sie mit  oder  die gewünschte Menüoption und drücken Sie die  Taste zur Eingabe.

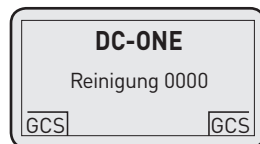

Nachdem Sie die  Taste gedrückt haben, erscheint:



Drücken Sie die  Taste 3 Sekunden lang zur Rückkehr zur Menüliste.

6. Rückstellung

(Zugriffsmöglichkeit für den Benutzer nach Eingabe des PW – nur für Punkt 6.2)

Mit dieser Funktion stellt der Benutzer die Periodenzählung der Kaffeedosierungen zurück.

Wählen Sie mit  oder  die gewünschte Menüoption und drücken Sie auf die  Taste zur Eingabe.

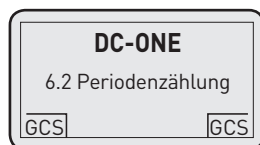

Nachdem Sie die  Taste gedrückt haben, erscheint:

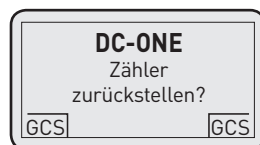

Nachdem Sie die  Taste gedrückt haben, erscheint auf dem Display:

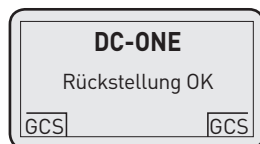

Drücken Sie die  Taste 3 Sekunden lang zur Rückkehr zur Menüliste.

7. Einstellungsmenü

[Zugriffsmöglichkeit nur für das Service-Personal]

Dieses Menü wird zur Einrichtung der Kaffeemühle benutzt.





8. Alarmmeldungen

[Zugriffsmöglichkeit für den Benutzer – ohne PW]

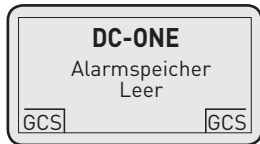
Dieses Menü enthält eine Liste der im Speicher der Mühle hinterlegten Alarmmeldungen (maximal 50 Alarmmeldungen können angezeigt werden).

Nachdem Sie die  Taste gedrückt haben, erscheinen die folgenden Daten:



Mit den  oder  Tasten zeigen Sie alle im Speicher der Kaffeemühle hinterlegten Alarmmeldungen an. Drücken Sie die  Taste zur Rückkehr zur Menülisten oder  3 Sekunden lang zur Rückkehr zur Hauptseite.

9. Test

[zugriff nur für das Servicepersonal]

Planmässige wartung

Die planmäßige Wartung bezieht sich auf die interne Reinigung des Geräts, die wöchentlich mit dem oben genannten Reinigungsgang "4. Burr cleaning" durchgeführt wird. Sie muss mit einem vom Hersteller für die Reinigung des Mahlwerks und des Mahlraums (und damit aller Teile, die mit Kaffee in Berührung kommen) vertriebenen Mittel durchgeführt werden.

Der äußere Bereich des Geräts sollte täglich mit

einem Reinigungsmittel gereinigt werden, das entfettend wirkt (kein Lösungsmittel!), geruchlos und für Flächen geeignet ist, die mit Nahrungsmitteln in Berührung kommen.

Verwenden Sie keine scheuernden Schwämme, damit die äußeren Teile nicht angegriffen werden.

Reinigen Sie den Innenbereich des Einfülltrichters für ganze Bohnen wöchentlich mit dem Spezialreinigungsmittel.

WARNHINWEIS

Falls die Kaffeemühle einige Tage lang nicht benutzt wird, muss ein Reinigungsgang vor erneuter Verwendung durchgeführt werden, damit keine alten Kaffeereste den Geschmack des frisch gemahlene Kaffees beeinträchtigen können.

Alarmmeldungen

Diese Kaffeemühle ist mit einer elektronischen Kontrolleinrichtung ausgestattet, die eine Reihe möglicher Unregelmäßigkeiten aufgrund des Versagens interner Teile oder falscher Verwendung überprüft und anzeigt.

Einige der Alarmmeldungen zeigen lediglich mögliche Störungen an, während andere die Kaffeemühle sperren. Falls ein Alarm ausgelöst wird, gehen Sie folgendermaßen vor:

ALARM	URSACHE	LÖSUNG
Datenverlust	Große Störung im elektrischen Netz	Schalten Sie die Mühle aus und wieder ein und arbeiten Sie weiter. Wenden Sie sich an den technischen Service
Verstopftes Mahlwerk	Der Kaffee enthält Verunreinigungen von beachtlicher Größe	Versuchen Sie es mit der Mahlwerkreinigung oder wenden Sie sich an den technischen Service
Unterbrochenes serielltes Kabel	Die Kaffeemaschine ist ausgeschaltet oder das serielle Kabel ist nicht eingesteckt	Schalten Sie die Mühle aus und wieder an und arbeiten Sie weiter. Wenden Sie sich an den technischen Service
Störung im triac board	Störung im Mahlmotor	Schalten Sie die Mühle aus und wieder an und arbeiten Sie weiter. Wenden Sie sich an den technischen Service
Geringe Spannung	Probleme mit der Spannungsversorgung	Schalten Sie die Mühle aus und wieder an und arbeiten Sie weiter. Wenden Sie sich an den technischen Service
Mahlwerk-reinigung	Ein Reinigungsgang ist notwendig	Starten Sie die Mahlwerkreinigung
Hohe Innen-temperatur	Der Motor ist überhitzt oder die Luftkühlung ist blockiert	Schalten Sie die Mühle aus und wieder an und arbeiten Sie weiter. Wenden Sie sich an den technischen Service
Hohe Kaffee-temperatur	Abnutzung des Mahlwerks	Schalten Sie die Mühle aus und wieder an und arbeiten Sie weiter. Wenden Sie sich an den technischen Service
Getriebemotor blockiert	Der Getriebemotor für die Mahlgradeinstellung ist blockiert	Schalten Sie die Mühle aus und wieder an und arbeiten Sie weiter. Wenden Sie sich an den technischen Service
Beschädigter Mahlwerksensor	Der Sensor für die Mahlwerkposition ist beschädigt	Schalten Sie die Mühle aus und wieder an und arbeiten Sie weiter. Wenden Sie sich an den technischen Service
Beschädigte NTC-Sonde	Der Sensor für die Motortemperatur ist beschädigt	Schalten Sie die Mühle aus und wieder an und arbeiten Sie weiter. Wenden Sie sich an den technischen Service
Beschädigte Pt1000-Sonde	Der Sensor für die Kaffeetemperatur ist beschädigt	Schalten Sie die Mühle aus und wieder an und arbeiten Sie weiter. Wenden Sie sich an den technischen Service



4.0

MANUAL DE USUARIO

¡Enhorabuena por la compra de su molinillo de café!

Esta máquina reúne numerosas características innovadoras tales como diseño ergonómico, tecnología revolucionaria, materiales de gran calidad y extrema facilidad de uso.

El presente manual está estructurado para ser un instrumento útil para familiarizarse con el uso de la máquina. Contiene todas las informaciones importantes acerca de las particularidades de funcionamiento, datos técnicos, instrucciones de uso y correcto mantenimiento. Leyendo el manual podrá obtener prestaciones de alto nivel. Siga las instrucciones paso a paso y tómese el tiempo necesario para descubrir todos los detalles de su nueva máquina de café.

Dotación del molino

- Un pincel de limpieza
- Un recipiente de recogida para café molido
- Un set de pastillas limpiadoras
- Manual de uso para el usuario

Advertencias generales

ATENCIÓN

Este aparato deberá usarse únicamente para la finalidad para la que fue concebido. Cualquier otro uso se considerará impropio e irracional. El fabricante no podrá ser considerado responsable de eventuales daños causados por el uso impropio, indebido o irracional. El aparato deberá ser usado exclusivamente por personal cualificado.

Leer atentamente las instrucciones y las advertencias contenidas en el presente manual pues contienen indicaciones importantes sobre el uso del aparato y sobre su funcionamiento.

En caso de tener que cambiar el cable de alimentación, usar únicamente el cable recomendado por el fabricante.

La seguridad eléctrica se consigue solo si la instalación eléctrica a la que se conecta el aparato dispone de una buena **instalación de puesta a tierra**.

La existencia de este requisito imprescindible deberá ser comprobada por personal cualificado. El fabricante y el instalador no serán considerados responsables de eventuales daños causados por falta o ineficiencia de la puesta a tierra de la instalación.

El uso de cualquier aparato eléctrico comporta el respeto de algunas reglas fundamentales tales como:

- No usar el aparato con las manos o los pies mojados o con los pies descalzos.
- El aparato no está destinado para el uso por parte de personas (niños incluidos) con capacidades físicas, sensoriales o mentales reducidas, o que

no tengan experiencia o conocimientos suficientes, salvo que haya una persona responsable de su seguridad, estén vigilados o hayan recibido instrucciones sobre el uso del aparato.

- Antes de efectuar cualquier operación de limpieza o mantenimiento ordinario, desenchufar el aparato de la red de alimentación eléctrica.
- Para limpiar el aparato, no lavarlo bajo un chorro de agua ni sumergirlo.
- No dejar el aparato encendido y sin vigilancia por largo tiempo (por ejemplo 1 día).
- Para garantizar la eficiencia del aparato y su correcto funcionamiento, es indispensable respetar las instrucciones del fabricante y efectuar el mantenimiento ordinario.
- La temperatura del lugar de trabajo del aparato deberá estar comprendida entre 5 °C y 35 °C.

En caso de permanencia temporal en un lugar con temperatura inferior a 0 °C, consultar exclusivamente al Servicio de Asistencia Técnica autorizado por el fabricante.

- En caso de avería y/o mal funcionamiento del aparato, apagarlo y abstenerse de todo intento de reparación directa. Dirigirse exclusivamente al Servicio de Asistencia Técnica autorizado por el fabricante.

GCS (GRINDER CONTROL SYSTEM)

Este molino de café cuenta con un sistema electrónico de gestión con el que se puede programar el tiempo de molido y el molido en modo digital; además, si está conectado mediante cable en serie a una máquina de café Dalla Corte de la serie evo2 o dc pro, el molino se ajusta automáticamente.

Este sistema controla y ajusta la molidura mediante la máquina de café espresso, que monitoriza cada erogación de café y, cuando los parámetros de extracción difieren de los programados durante la fase de instalación del sistema, envía al molino la orden de modificar el punto y el tiempo de molido.

Preparación para la instalación

ATENCIÓN

La instalación deberá ser efectuada respetando las leyes vigentes, de acuerdo con las instrucciones del fabricante y por parte de personal cualificado. Una instalación errónea puede causar daños a las personas, animales o cosas. El fabricante no será considerado responsable de eventuales daños que pudieran derivarse de una instalación errónea.

Para la instalación del aparato hay que predisponer una superficie de apoyo estable y firme, cerca de la máquina de café, de 30 cm de ancho, 40 cm de profundidad y 70 cm de altura útil, y una toma de corriente monofásica del tipo previsto en las normas del país de instalación de 10-16 amp. Quitar el embalaje y comprobar la integridad del aparato y, en caso de duda, no utilizarlo. No dejar al alcance de los niños los componentes del embalaje pues estos constituyen una fuente de peligro potencial. Antes de conectar el aparato a la instalación eléctrica, comprobar que los datos de la placa correspondan con los del lugar de instalación.

En caso de tener que cambiar el cable de alimentación del aparato, dirigirse al instalador del mismo.



Descripción general y puesta en funcionamiento del molino de café

Fig. 1

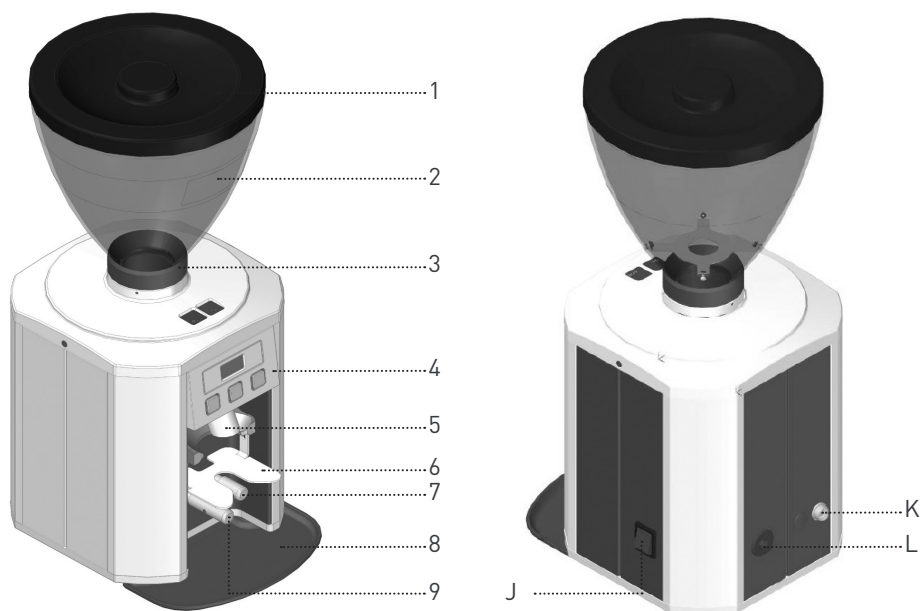

1 Tapa tolvá

2 Tolvá de café

3 Tornillo fijación campana

4 Panel de mando

5 Salida de café

6 Soporte portafiltro

7 Palpador de dosis simple

8 Palpador recogida café

9 Palpador de dosis doble

J Interruptor general

K Conector en serie RS232

L Toma de alimentación

Descripción del panel de mando

Fig. 2



Menú de desplazamiento y selección, arriba y abajo





Botón de confirmación, acceso a la configuración

Puesta en funcionamiento del molino de café

Encender el interruptor general del aparato (Fig.1). Cuando aparece en el display el mensaje que se muestra en el esquema de aquí abajo, el molino está listo para empezar a funcionar.

El café molido con el molino dc one se puede obtener mediante 2 modalidades, que configurará el instalador durante la fase de instalación:

Modalidad 1

- Pulsando  se obtiene 1 dosis de café molido
- Pulsando  se obtiene 2 dosis de café molido

Modalidad 2

Al introducir el portafiltro en el soporte correspondiente, dc one reconoce automáticamente qué dosis debe suministrar.

En esta modalidad, si se quita el portafiltro del soporte antes de terminar la erogación de café molido, la erogación se interrumpe manteniendo en la memoria el tiempo residual de molido (la tecla de la dosis que se interrumpe parpadea en modo constante como recordatorio).

Si se desea anular el tiempo residual, basta con pulsar la tecla que parpadea para anular la operación.

Ajustes

Para entrar en el menú principal y ver los datos o modificar los parámetros de configuración del molino dc one, pulsar 3 segundos la tecla  Esquema de secuencia de los menús.

Esquema de flujo de los menús

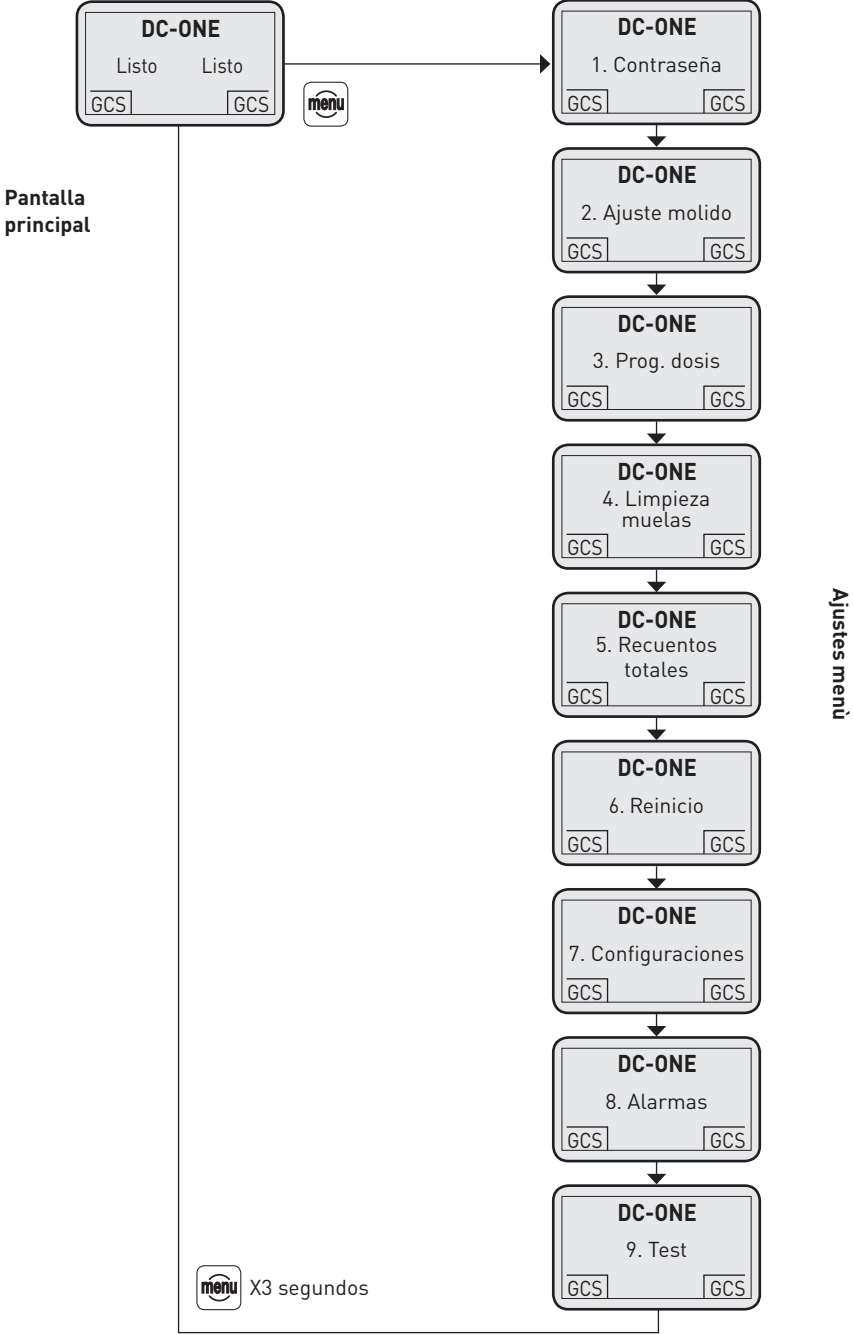

1. Contraseña

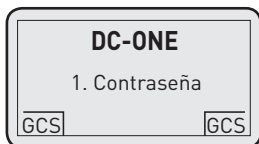

Pulsando la tecla  se visualiza:

1.1 - Insertar

1.2 - Modificar



Con  o  seleccionar la opción INSERTAR y pulsar  para entrar, se visualiza:

1.1.1 - Usuario

1.1.2 - Servicio

Con  o  seleccionar la opción INSERTAR y pulsar  para entrar, se visualiza:



Insertar 0000

Para introducir la contraseña desplazarse con las teclas  o  hasta la cifra deseada y pulsar .

NOTA

En caso de introducir una contraseña errónea, repetir desde el principio la operación de inserción.

Después de introducir la última cifra, pulsar  para confirmar y volver a la lista de menús.

Con  o  se puede desplazar por la lista de los otros menús, pero si se tiene pulsado 3 segundos  se vuelve a la pantalla principal.

Si el usuario introduce la contraseña y la identificación de usuario puede acceder a algunos menús de configuración.

La contraseña de usuario es 0000.

2. Ajuste de molido

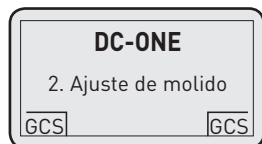

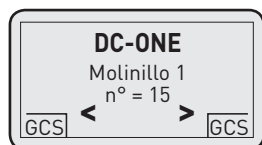

(Puede acceder el usuario con la contraseña, si el sistema GCS está desactivado)

Pulsando la tecla  Taste gedrückt haben, erscheint auf dem Display:



Con  o  se puede modificar la granulometría del café molido.

Pulsando la tecla  se vuelve a la lista de menús.

Con  o  Taste. se puede desplazar por la lista de los otros menús, y pulsando  3 segundos se vuelve a la pantalla principal.

NOTA

Durante la puesta a punto del molido se pueden extraer las dosis de café molido sin salir del menú anterior, para acelerar el proceso de ajuste del molino.

3. Programación de las dosis

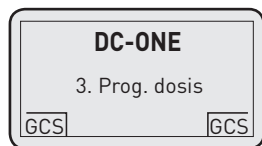

(Puede acceder el usuario con la contraseña, si el sistema GCS está desactivado)

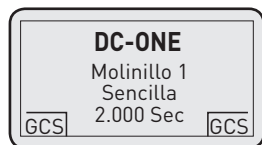

Pulsando la tecla  se visualiza:





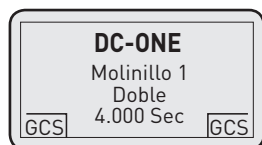

Con  o  se puede modificar el tiempo de molido (y por lo tanto la dosis) de la dosis simple.

Pulsar la tecla  para confirmar y pasar al dato siguiente:



Con  o  se puede modificar el tiempo de molido (y por lo tanto la dosis) de la dosis doble.

Pulsar la tecla  para confirmar el dato y volver al menú anterior.

Con  o  se puede desplazar por la lista de los otros menús, y pulsando  3 segundos se vuelve a la pantalla principal.

4. Limpieza de las muelas

[Puede acceder el usuario sin contraseña]

El usuario puede usar esta función para realizar periódicamente un ciclo de limpieza de la cámara de molturación (se aconseja efectuarlo semanalmente).

Para el ciclo de limpieza se usará el producto limpiador específico que deberá comprarse exclusivamente al instalador del molino. Quitar todos los granos de café de la tolva.

Pulsando la tecla  se visualiza:

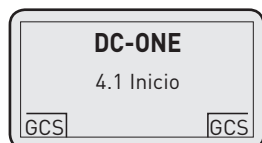

Pulsando la tecla  se visualiza:

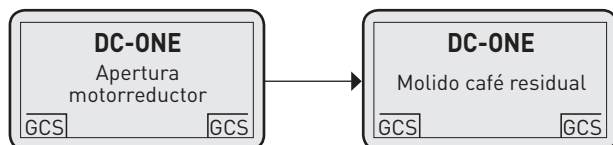

Si se desea utilizar el café molido que sale, recogerlo en un recipiente para alimentos.

Después del molido del café residual, en la pantalla aparece:

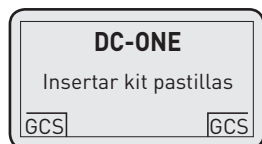

Echar el producto limpiador en la tolva.

Pulsando la tecla  se visualiza:

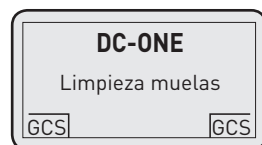

Durante esta fase, recoger el producto limpiador molido y echarlo en los residuos orgánicos.

Al terminar el ciclo de limpieza se visualiza:

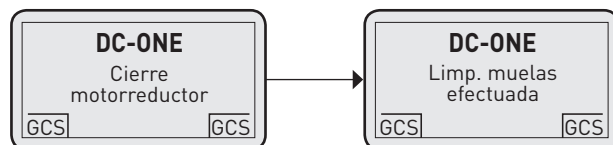

Pulsando 3 segundos la tecla  se vuelve a la pantalla principal.

5. Recuentos

[Puede acceder el usuario sin contraseña]

Esta función sirve para ver todos los contadores de café.

Pulsando la tecla  se visualiza:

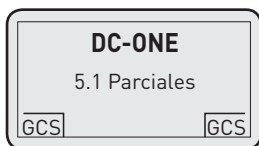

Con  o  seleccionar la opción deseada y pulsar  para entrar.

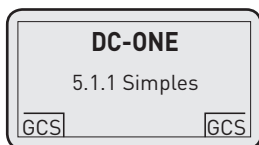

Pulsando la tecla  se visualiza:

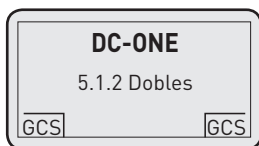
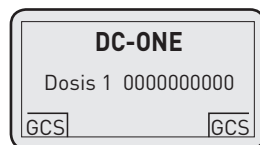

Pulsando la tecla  se visualiza:

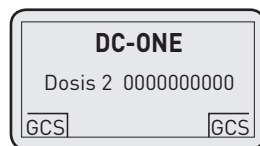

Pulsando 3 segundos la tecla  se vuelve al menú 5- Recuentos.

Con  o  seleccionar la opción deseada y pulsar  para entrar.

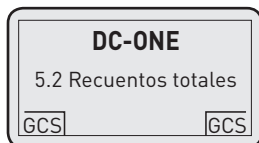

Con  o  seleccionar la opción deseada y pulsar  para entrar.

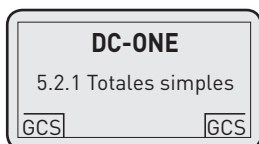

Pulsando la tecla  se visualiza:

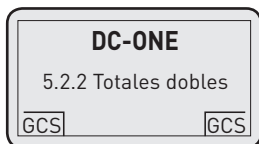
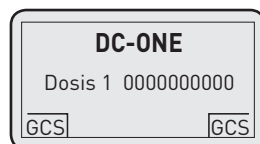

Pulsando la tecla  se visualiza:

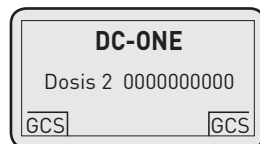

Pulsando 3 segundos la tecla  se vuelve al menú 5- Recuentos.

Con  o  seleccionar la opción deseada y pulsar  para entrar.

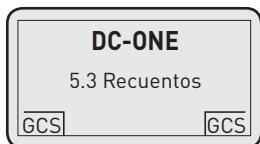

Pulsando la tecla  se visualiza:

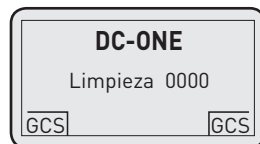

Pulsando 3 segundos la tecla  se vuelve a la lista de menús.

6. Reinicio

[Puede acceder el usuario sin contraseña, solo 6.2]

Mediante esta función el usuario puede poner a cero los contadores parciales de café.

Con  o  seleccionar la opción deseada y pulsar  para entrar.

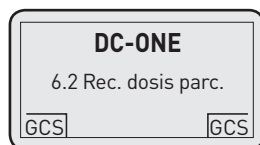

Pulsando la tecla  se visualiza:

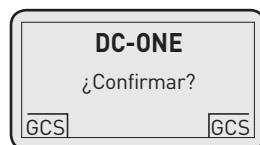

Pulsando la tecla  se visualiza:

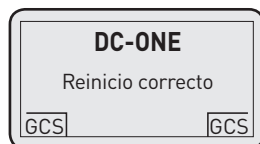

Pulsando 3 segundos la tecla  se vuelve a la lista de menús.

7. Menú de configuraciones

[Puede acceder solo el servicio técnico]

Con este menú se efectúan todas las configuraciones del molino.



8. Alarmas

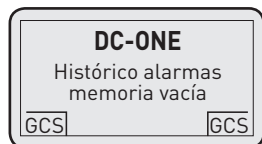

[Puede acceder el usuario sin contraseña]

Con este menú se puede visualizar el archivo histórico de alarmas de la memoria del molino de café (se puede ver hasta un máximo de 50 alarmas).

Pulsando la tecla  se visualiza:



Con  o  se pueden visualizar todas las alarmas que se encuentran en la memoria del molino de café.

Pulsando la tecla  se vuelve a la lista de menús o si se tiene pulsada 3 segundos  se vuelve a la pantalla principal.

9. Test

[puede acceder solo el servicio técnico]

Mantenimiento ordinario

Por mantenimiento ordinario se entiende la limpieza interior que deberá efectuarse semanalmente con el producto especial comercializado por el fabricante para la limpiar las muelas y la cámara de molturación (es decir, todas las partes que entran en contacto con el café) en el citado ciclo de limpieza “4. Limpieza de las muelas”.

Para la limpieza diaria de la parte exterior deberá

usarse un producto desengrasante sin disolventes, inodoro y adecuado para limpiar superficies en contacto con alimentos.

No utilizar esponjas abrasivas para evitar arruinar la parte exterior.

Semanalmente, limpiar el interior de la tolva de granos de café utilizando el detergente especial citado.

ATENCIÓN

En caso de no utilizar durante varios días el molino de café, efectuar un ciclo de limpieza de las muelas antes de volver a usarlo, para evitar que los residuos de café viejo alteren el sabor del café recién molido.

Alarmas

Este molino de café dispone de un control electrónico que permite identificar y señalar una serie de posibles anomalías causadas por la avería de alguna pieza interna o por un uso incorrecto.

Algunas de estas alarmas son solo de señalación, mientras que otras bloquean el molino.

En caso de alarma, proceder como se indica a continuación.

ALARMA	CAUSA	SOLUCIÓN
Pérdida de datos	Mucha interferencia en la red eléctrica	Apagar y volver a encender el molino para trabajar y llamar al técnico
Muela bloqueada	Impurezas del café de tamaño grande	Efectuar un ciclo de limpieza de las muelas. Si no se soluciona el problema, llamar al técnico
Fallo de la línea en serie	Máquina de café apagada o cable en serie desconectado	Apagar y volver a encender el molino para trabajar y llamar al técnico
Triac averiado	Problema en el motor de molturación	Apagar y volver a encender el molino para trabajar y llamar al técnico
Baja tensión	Problemas de tensión de alimentación	Apagar y volver a encender el molino para trabajar y llamar al técnico
Limpieza muelas	Indica que es necesario efectuar un ciclo de limpieza	Efectuar el ciclo de limpieza de las muelas
Alta temperatura interior	Exceso de temperatura en el motor y/o ventilación bloqueada	Apagar y volver a encender el molino para trabajar y llamar al técnico
Alta temperatura del café	Muelas desgastadas	Apagar y volver a encender el molino para trabajar y llamar al técnico
Bloqueo del motorreductor	Motorreductor de ajuste de molido bloqueado	Apagar y volver a encender el molino para trabajar y llamar al técnico
Sensor Hall averiado	Sensor de posición de las muelas averiado	Apagar y volver a encender el molino para trabajar y llamar al técnico
Sonda NTC averiada	Sensor de temperatura del motor averiado	Apagar y volver a encender el molino para trabajar y llamar al técnico
Sonda PT1000 averiada	Sensor de temperatura del café averiado	Apagar y volver a encender el molino para trabajar y llamar al técnico



5.0

NOTICE POUR L'UTILISATEUR

Félicitations pour l'achat de cette moulin à café

Elle possède de multiples caractéristiques innovantes: technologie révolutionnaire, design ergonomique, standard qualitatif élevé matériel et emploi extrêmement facile.

Cette notice est faite de manière à devenir un instrument utile pour qu'il soit possible de se familiariser avec le moulin à café. Vous y trouverez tous les renseignements importants sur ses caractéristiques de fonctionnement, ainsi que des renseignements techniques, le mode d'emploi et la notice pour un entretien correct. En faisant attention à tout ce qui se trouve dans cette notice, vous découvrirez que vous pouvez obtenir des performances de haut niveau. Feuilletez-la et suivez les instructions pas à pas en prenant tout le temps qu'il faut pour découvrir votre nouvelle machine dans tous ses détails.

Accessoires du moulin à café

- Mode d'emploi pour l'utilisateur
- Pinceau pour le nettoyage
- Récipient pour le café moulu
- Produit pour le nettoyage à l'intérieur du moulin à café (échantillon pour un nettoyage)

Instructions générales

ATTENTION

Cet appareil ne doit servir que pour l'emploi pour lequel il a été conçu. Il est considéré que tout autre emploi est erroné, donc déraisonnable. Le fabricant ne peut pas être estimé responsable de dommages éventuels causés par un emploi inadéquat, erroné et déraisonnable. L'emploi de cet appareil ne doit être confié qu'à du personnel qualifié.

Il faut lire attentivement les instructions et les avertissements se trouvant dans cette notice, car ils fournissent des indications importantes sur l'emploi de l'appareil et son fonctionnement.

En cas de substitution du câble d'alimentation de l'appareil, il ne faut utiliser que le câble conseillé par le fabricant.

La sûreté du point de vue électrique n'est assurée que lorsque l'équipement électrique auquel brancher l'appareil est relié correctement à un **système de mise à la terre**.

Il faut faire vérifier ces conditions fondamentales par du personnel qualifié. Le fabricant et l'installateur ne peuvent pas être considérés comme responsables de dommages éventuels causés par l'absence du système de mise à la terre ou son manque d'efficacité.

L'emploi de tout appareil électrique implique également d'observer certaines règles fondamentales:

- il ne faut pas utiliser l'appareil avec des mains ou des pieds mouillés ni avec des pieds nus.
- L'appareil ne doit pas être utilisé par des personnes (enfants compris) dont les capacités physiques, sensorielles ou mentales sont réduites, ou encore manquant d'expérience et des notions

nécessaires, sauf si elles ont pu bénéficier, par l'intermédiaire d'une personne responsable de leur sûreté, d'une surveillance ou d'instructions concernant l'emploi de l'appareil.

- Avant d'effectuer toute opération de nettoyage ou d'entretien de routine, il faut débrancher l'appareil de la prise de courant.
- Pour nettoyer l'appareil, il ne faut pas le laver avec des jets d'eau ou le plonger dans de l'eau.
- Ne pas laisser l'appareil allumé et sans surveillance, pendant longtemps (1 jour, par exemple).
- Pour garantir l'efficacité de l'appareil et pour en assurer le fonctionnement correct, il est indispensable de se conformer aux indications du fabricant pour exécuter l'entretien de routine.
- La température de l'environnement où fonctionne l'appareil doit être comprise entre un minimum de 5° et un maximum de 35°C.

Dans le cas d'un séjour temporaire dans un endroit dont la température est inférieure à 0°, il faut s'adresser uniquement au service après-vente autorisé par le fabricant.

- En cas de panne et/ou de mauvais fonctionnement de l'appareil, il faut l'éteindre en s'abstenant de toute tentative de réparation directe. Il faut s'adresser uniquement au service après-vente autorisé par le fabricant.

GCS (GRINDER CONTROL SYSTEM)

Ce moulin à café dispose d'un système électronique de gestion prévoyant la possibilité de programmer le temps de mouture et la mouture numérique; de plus, s'il est branché avec un câble sériel spécial à une machine à café Dalla Corte de la série evo2 ou dc pro, il est possible de régler le moulin à café automatiquement.

Ce système contrôle et règle la mouture par l'intermédiaire de la machine à café espresso, qui surveille chaque distribution de café; quand les paramètres d'extraction ne sont pas conformes à ceux qui ont été programmés au moment de l'installation du système, il envoie au moulin à café la commande de modification de la taille de la mouture et du temps de mouture.

Préparatifs pour l'installation

ATTENTION

L'installation doit être effectuée conformément aux lois en vigueur, en respectant les instructions du fabricant et du personnel qualifié. Une installation erronée peut causer des dommages corporels (animaux et personnes) ou matériels. Le fabricant ne peut pas être considéré comme responsable de dommages causés par une installation erronée.

Pour l'installation de cet appareil, il faut préparer un plan d'appui stable et sûr près de la machine à café; celui-ci doit faire 30 cm de large, 40 cm de profondeur et avoir une hauteur utile de 70 cm, ainsi que disposer d'une prise de courant monophasé de 10-16 ampères, du type prévu par les normes locales à l'endroit de l'installation.

Après avoir éliminé l'emballage, il faut vérifier l'intégrité de l'appareil, et ne pas l'utiliser en cas de doute.

Les éléments de l'emballage ne doivent pas être laissés à la portée des enfants car ils peuvent être dangereux.

Avant de brancher l'appareil au courant, il faut vérifier si les données de la plaque correspondent à celles de l'endroit prévu pour l'installation.

S'il est nécessaire de changer de câble d'alimentation pour l'appareil, il faut s'adresser à l'installateur.



Description générale et mise en marche du moulin à café

Fig. 1

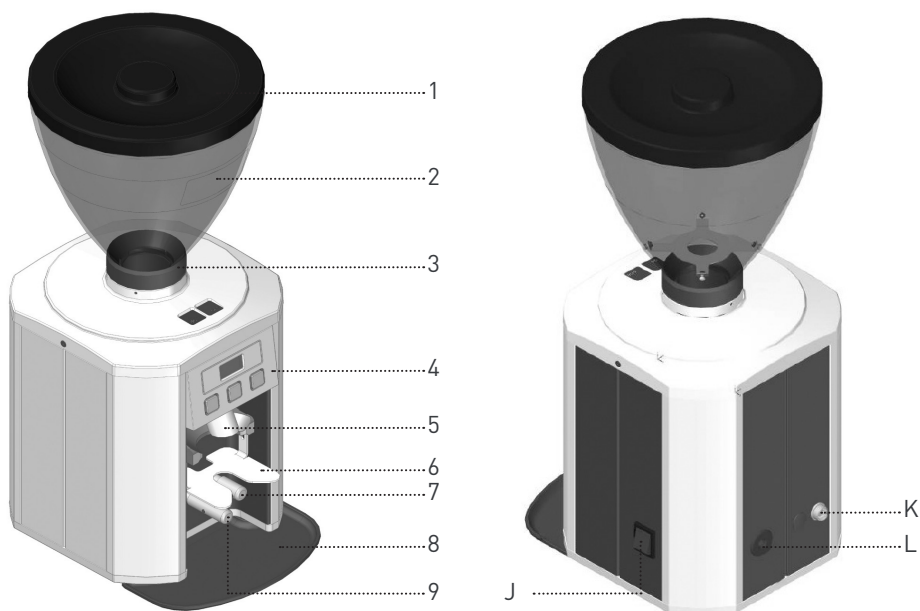

- 1 Couvercle trémie
- 2 Trémie café
- 3 Vis de blocage
- 4 anneau commandes
- 5 Sortie café
- 6 Support Porte-filtre

- 7 Touche pour dose simple
- 8 Plateau de ramassage café
- 9 Touche pour dose double
- J Interrupteur général
- K Connecteur sériel RS232
- L Prise d'alimentation

Description panneau commande

Fig. 2

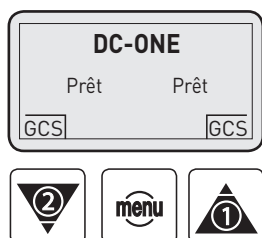

Bouton de sélection, haut/bas





Bouton de confirmation, accès aux paramètres

Mise en marche du moulin à café

Allumer l'interrupteur général de l'appareil (Fig. 1). Quand on voit apparaître sur l'affichage ce que montre le schéma, ceci signifie que le moulin à café est prêt.

Le café moulu à l'aide du moulin dc one peut être obtenu à l'aide de 2 modalités que peut régler l'installateur pendant la phase de programmation;

Modalité 1

- En appuyant sur  on obtient 1 dose de café
- En appuyant sur  on obtient 2 doses de café

Modalité 2

Si on introduit le porte-filtre dans le support prévu à cet effet, dc one reconnaît automatiquement la dose à distribuer.

Dans le cas de cette modalité, si l'on retire le porte-filtre du support avant la fin de la distribution du café moulu, la distribution s'interrompt tout en maintenant dans la mémoire le temps de mouture restant (la touche de la dose interromptue clignote continuellement pour le signaler).

Si l'on veut annuler le temps restant, il suffit d'appuyer sur la touche qui clignote pour annuler le tout.

Réglages

Pour entrer dans le menu principal pour visualiser les données ou modifier les paramètres de réglage du moulin à café dc one, il faut appuyer sur la touche pendant 3 secondes.

Schéma de principes des menus

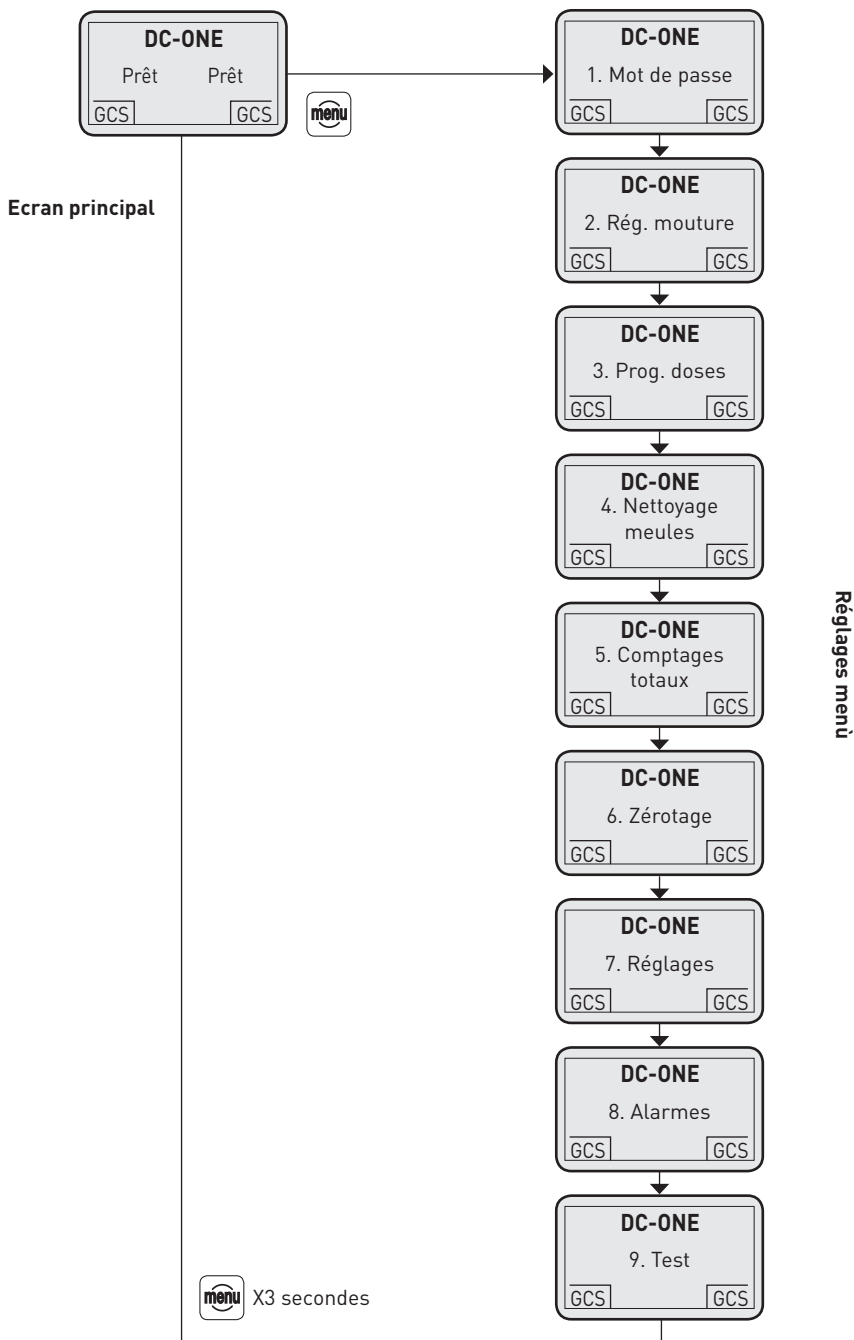

1. Passwort (PW)

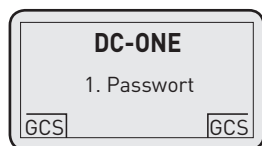

En appuyant sur la touche  on visualise:

1.1 - Insertion

1.2 - Modification



Se servir de  ou de  pour sélectionner INSERTION et appuyer sur  pour entrer et visualiser:

1.1.1 - Benutzer

1.1.2 - Service





Se servir de  ou de  pour sélectionner USER et appuyer sur  pour entrer et visualiser:

Inserisci 0000

Pour introduire le mot de passe, il faut utiliser les touches  ou de  et – une fois que le chiffre correct a été atteint - appuyer sur .

NOTE

S'il y a erreur de mot de passe, il faut répéter l'opération depuis le début.

À la fin de l'insertion du dernier chiffre, en appuyant sur  pour la confirmer, on revient à la liste menu. Avec  ou de , il est possible de faire défiler la liste des autres menus; par contre en appuyant sur  pendant 3 secondes, on revient à l'affichage principal.

En introduisant le mot de passe de l'USER, celui-ci pourra accéder à certains menus de réglage.

Le mot de passe de l'utilisateur est 0000.

2. Réglage mouture

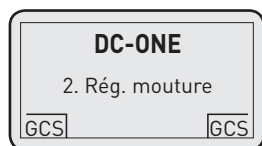

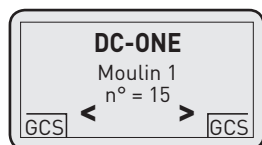

(accessible de la part de l'utilisateur avec le mot de passe si le système GCS est désactivé)

En appuyant sur la touche  on visualise:



Avec  ou de , il est possible de modifier la granulométrie du café moulu.

En appuyant sur la touche  on revient à la liste menu.

Avec  ou de , il est possible de faire défiler la liste des autres menus; par contre en appuyant sur  pendant 3 secondes, on revient à l'affichage principal.

NOTE

Pendant la mise au point de la mouture il est possible de prélever les doses de café moulu sans devoir sortir du menu précédent, ce qui permet d'accélérer le processus de régulation du moulin à café.

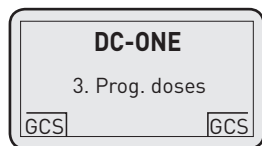

3. Programmation doses





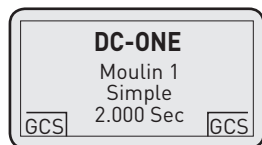

(accessible de la part de l'utilisateur avec le mot de passe si le système GCS est désactivé)

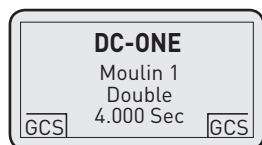

En appuyant sur la touche  on visualise:



Avec  ou de , il est possible de modifier le temps de mouture (et donc la dose) de la dose simple. En appuyant sur la touche  on confirme et on passe à la donnée suivante:



Avec  ou de , il est possible de modifier le temps de mouture (et donc la dose) de la dose double. En appuyant sur la touche  on confirme et on revient au menu précédent.

Avec  ou de , il est possible de faire défiler la liste des autres menus; par contre en appuyant sur  pendant 3 secondes, on revient à l'affichage principal.

4. Nettoyage meules

[accessible de la part de l'utilisateur sans mot de passe]

Cette fonction a pour but de permettre à l'utilisateur d'exécuter un cycle de nettoyage de la chambre de mouture périodiquement (il est conseillé de le faire toutes les semaines).

Ce cycle de nettoyage doit se faire avec le produit détergent prévu à cet effet à n'acheter que chez l'installateur du moulin à café. Enlever tout le café en grains de la trémie.

En appuyant sur la touche  on visualise:

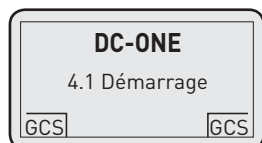

En appuyant sur la touche  on visualise:

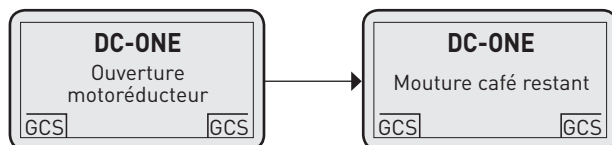

Se servir d'un récipient alimentaire pour récupérer le café qui est moulu, si on veut l'utiliser.

Tout de suite après la mouture du café restant, l'affichage visualise:

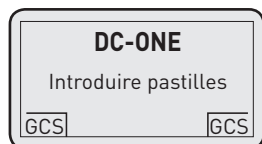

Mettre le produit détergent dans la trémie.

En appuyant sur la touche  on visualise:

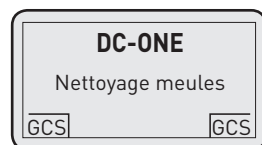

Pendant cette phase, il récupérer le produit détergent moulu et le jeter dans les ordures organiques.

À la fin du cycle de nettoyage on visualise:

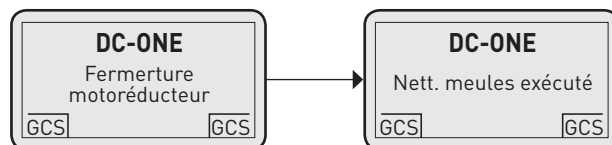

En appuyant sur la touche  pendant 3 secondes, on revient à l'affichage principal.



5. Comptages

(accessible de la part de l'utilisateur sans mot de passe)

Cette fonction sert à visualiser tous les compteurs de café.

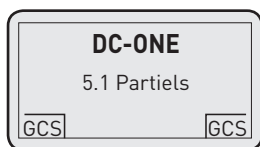
En appuyant sur la touche  on visualise:



Se servir de  ou de  pour indiquer le poste voulu et appuyer sur  pour entrer.

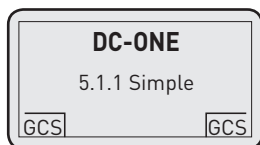

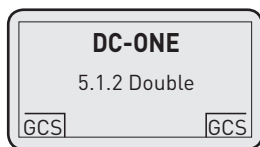
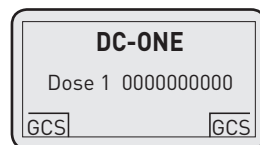

En appuyant sur la touche  on visualise:



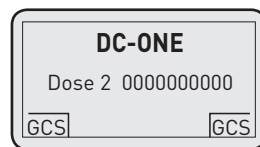



En appuyant sur la touche  on visualise:



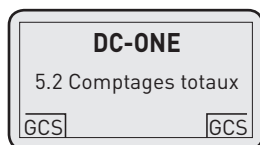

Appuyer sur la touche  pendant 3 secondes pour revenir au menu 5. Comptages.

Se servir de  ou de  pour indiquer le poste voulu et appuyer sur  pour entrer.

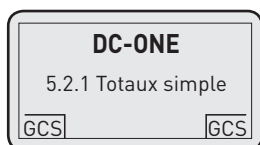

Se servir de  ou de  pour indiquer le poste voulu et appuyer sur  pour entrer.



En appuyant sur la touche  on visualise:

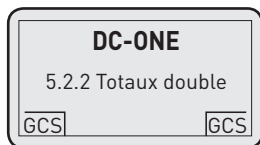
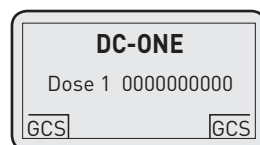

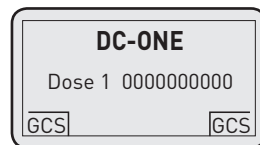

En appuyant sur la touche  on visualise:

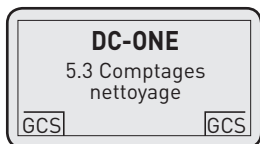

Appuyer sur la touche  pendant 3 secondes pour revenir au menu 5. Comptages.

Se servir de  ou de  pour indiquer le poste voulu et appuyer sur  pour entrer.



En appuyant sur la touche  on visualise:

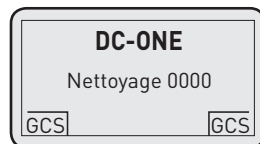

En appuyant sur la touche  pendant 3 secondes, on revient à la liste menu.

6. Zérotage

(accessible de la part de l'utilisateur avec le mot de passe, seul 6.2)

Cette fonction permet à l'utilisateur de mettre à zéro les compteurs de cafés partiels.

Se servir de  ou de  pour indiquer le poste voulu et appuyer sur  pour entrer.

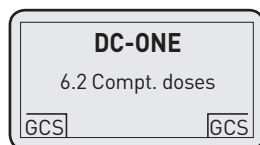

En appuyant sur la touche  on visualise:

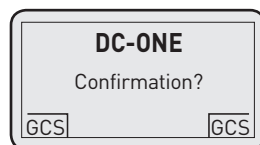

En appuyant sur la touche  on visualise:

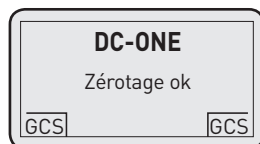

En appuyant sur la touche  pendant 3 secondes, on revient à la liste menu.

7. Réglages

(accessible uniquement pour le service)

Ce menu sert à donner tous les réglages au moulin à café.

8. Alarmes



(accessible de la part de l'utilisateur sans mot de passe)

Dans ce menu il est possible de visualiser l'historique des alarmes présente dans la mémoire du moulin à café. (il est possible de visualiser jusqu'à un maximum de 50 alarmes)

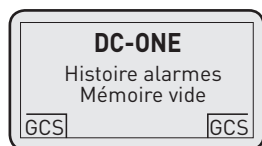
En appuyant sur la touche  on visualise:



Avec  ou de  il est possible de visualiser toutes les alarmes, s'il y en a, dans la mémoire du moulin à café.

En appuyant sur la touche  on revient à la liste menu ou sur  pendant 3 secondes on revient à l'affichage principal.

9. Test

(accessible uniquement pour le service)

Entretien de routine

L'entretien de routine concerne le nettoyage à l'intérieur de la machine, qui doit se faire avec le produit spécial commercialisé par le fabricant pour le nettoyage des meules et de la chambre de mouture (soit toutes les parties en contact avec le café) en effectuant le cycle de nettoyage décrit dans le paragraphe "4. Nettoyage meules".

Pour le nettoyage quotidien à l'extérieur, il faut

utiliser un produit dégraissant mais qui ne soit pas un solvant, inodore et donc indiqué pour nettoyer des surfaces en contact avec des aliments.

Il ne faut pas utiliser d'éponges abrasives pour éviter d'abîmer les parties extérieures.

Toutes les semaines - et toujours avec le détergent ad hoc - il faut nettoyer l'intérieur de la trémie du café en grains.

ATTENTION

Si on ne sert pas du moulin à café pendant quelques jours, il faut effectuer un cycle de nettoyage des meules avant de le réutiliser, pour éviter que des résidus de vieux café ne puissent donner un mauvais goût à la nouvelle mouture.

Alarmes

Ce moulin à café a un contrôle électronique qui permet de vérifier et de signaler une série d'anomalies possibles dues à une panne d'une pièce à l'intérieur ou à un emploi qui ne se fait pas correctement.

Certaines de ces alarmes ne sont que des signaux, d'autres par contre impliquent des blocages du moulin à café.

Dans le cas d'une alarme, il faut procéder de la façon suivante.

ALARME	CAUSE	SOLUTION
Perte de données	Grosse interférence sur le réseau électrique	Éteindre et rallumer le moulin à café pour travailler et appeler le technicien
Meule bloquée	Saleté de grosse taille dans le café	Essayer avec le cycle de nettoyage des meules, sinon appeler le technicien
Ligne sérielle endommagée	Machine à café éteinte ou câble sériel débranché	Éteindre et rallumer le moulin à café pour travailler et appeler le technicien
Triac en panne	Problème du moteur de mouture	Éteindre et rallumer le moulin à café pour travailler et appeler le technicien
Basse tension	Problèmes de voltage d'alimentation	Éteindre et rallumer le moulin à café pour travailler et appeler le technicien
Nettoyage meules	Signalant qu'un cycle de nettoyage est nécessaire	Effectuer le cycle de nettoyage des meules
Haute température à l'intérieur	Surchauffe du moteur et/ou ventilation bloquée	Éteindre et rallumer le moulin à café pour travailler et appeler le technicien
Haute température du café	Meules usagées	Éteindre et rallumer le moulin à café pour travailler et appeler le technicien
Bloc motoréducteur	Motoréducteur pour la régulation de la mouture bloqué	Éteindre et rallumer le moulin à café pour travailler et appeler le technicien
Capteur hall détraqué	Capteur de position des meules en panne	Éteindre et rallumer le moulin à café pour travailler et appeler le technicien
Sonde ntc en panne	Capteur de température du moteur en panne	Éteindre et rallumer le moulin à café pour travailler et appeler le technicien
Sonde pt1000 en panne	Capteur de température du café en panne	Éteindre et rallumer le moulin à café pour travailler et appeler le technicien

DICHIARAZIONE CE DI CON-FORMITA'DIRETTIVA 2006/42/EC

La sottoscritta società: **DALLA CORTE S.R.L.**

Con sede in: Via Zambelletti, 10 / Baranzate (MI), ITALY

Dichiara che la macchina per caffè espresso:

È conforme ai requisiti essenziali della Direttiva 2006/42/EC ed alla legislazione nazionale che la recepisce, avendo seguito la seguente procedura di valutazione di conformità: Norma UNI 9887, ISPSEL rev. 95

L'insieme a pressione è composto da una caldaia dotata di dispositivi di sicurezza e regolazione, utilizzato per la preparazione rapida di caffè espresso, vapore ed infusi.

L'insieme soddisfa anche le seguenti Direttive Comunitarie: 2006/42/EC - 2006/95/CE - 2004/108/EC

EEC CONFORMITY DECLARATION ACT 2006/42/EC

The undersigned: **DALLA CORTE S.R.L.**

With premises at: Via Zambelletti 10, Baranzate (Milan), ITALY

Declares that:

The espresso coffee machine has been projected and manufactured in conformity with Directive 2006/42/EC and relevant national law, in accordance with the following norm for conformity evaluation: UNI 9887, ISPSEL rev. 95

The pressure element is composed of a boiler with safety devices and regulation, used for the quick preparation of espresso, steam and infusions.

The pressure element conforms to the EEC directive: 2006/42/EC - 2006/95/CE - 2004/108/EC

EWG KONFORMITÄTSERKLÄRUNG RICHTLINIE 2006/42/EG

Der Unterzeichner: **DALLA CORTE S.R.L.**

Mit Sitz in: Via Zambelletti 10, Baranzate (Mailand), ITALIEN

Erklärt dass:

Die Espresso-Kaffeemaschine gemäß der Richtlinien 2006/42/EG und entsprechenden nationalen Gesetzen gemäß den folgenden Normen zur Konformitätsbewertung projektiert und hergestellt wurde: UNI 9887, ISPSEL rev. 95

Die Druckelemente bestehen aus einem Boiler mit Sicherheitseinrichtungen und Regulierung für die schnelle Zubereitung von Espresso, Dampf und Infusionen.

Das Druckelement entspricht der EWG-Richtlinie: 2006/42/EG - 2006/95/EG - 2004/108/EG

DECLARACIÓN DE CONFORMIDAD CE (DIRECTIVA CE 2006/42/CE)

La sociedad abajo firmante: **DALLA CORTE S.R.L.**

Con domicilio social en: Via Zambelletti 10, Baranzate (Milan), ITALY

Declara que la máquina de café espresso:

Cumple las disposiciones aplicables de la Directiva 2006/42/CE y la legislación nacional que la traspone y ha sido sometida al siguiente procedimiento de valoración de conformidad: Norma UNI 9887, ISPSEL rev. 95

El conjunto de presión está compuesto por una caldera dotada de dispositivos de seguridad y regulación y se utiliza para la preparación rápida de café espresso, vapor e infusiones.

El citado conjunto también es conforme a las siguientes Directivas Comunitarias: 2006/42/EC - 2006/95/CE - 2004/108/EC

DÉCLARATION CE DE CONFORMITÉ DIRECTIVE 2006/42/EC

La société soussignée: **DALLA CORTE S.R.L.**

Adresse du siège: Via Zambelletti 10, Baranzate (Milan), ITALY

Déclare que la machine à café espresso:

est conforme aux exigences essentielles de la Directive 2006/42/EC et à la législation nationale qui l'a adoptée, puisqu'elle a suivi la procédure suivante d'évaluation de conformité: Norme UNI 9887, ISPSEL rev. 95

L'ensemble à pression est fait d'une chaudière équipée de dispositifs de sécurité et de régulation, utilisé pour la préparation rapide de café espresso, vapeur et infusions.

L'ensemble répond aussi aux directives communautaires suivantes: 2006/42/EC - 2006/95/CE - 2004/108/EC

DICHIARAZIONE DI CONFORMITÀ CE

Produttore: **DALLA CORTE S.R.L.**

Con sede in: Via Zambelletti 10, Baranzate (MI), ITALY

La macchina per caffè espresso è conforme alle prescrizioni delle seguenti normative:

- 2004/108/EC Direttiva Compatibilità Elettromagnetica con applicazione delle seguenti parti/clause di norme armonizzate: EN 61000-3-2:2006 + A1:2009 + A2:2009, EN 61000-3-3 :2008, EN 55014-1:2006 + A1:2009, EN 55014-2 :1997 + A1:2001 + A2:2008
- 2006/95/CE Direttiva Bassa Tensione con applicazione delle seguenti parti/clause di norme armonizzate: EN 60335-1:2002 + A1:2004 + A11:2004 + A12:2006 + A2:2006 + A13:2008, EN 60335-2-75:2004 + A1:2005 + A11:2006 + A2:2008 + A12:2010, EN 62233:2008

Milano, Italia, 21 aprile 2011

Il Presidente del C.d.A.

Paolo Dalla Corte

EEC CONFORMITY DECLARATION

Manufacturer: **DALLA CORTE S.R.L.**

With premises at: Via Zambelletti 10, Baranzate (Milan), ITALY

The espresso coffee machine conforms to the following EEC acts:

- Electromagnetic Compatibility Directive 2004/108/EC, with the application of the following clauses: EN 61000-3-2:2006 + A1:2009 + A2:2009, EN 61000-3-3:2008, EN 55014-1:2006 + A1:2009, EN 55014-2:1997 + A1:2001 + A2:2008
- Low Voltage Directive 2006/95/EC, with the application of the following clauses: EN 60335-1:2002 + A1:2004 + A11:2004 + A12:2006 + A2:2006 + A13:2008, EN 60335-2-75:2004 + A1:2005 + A11:2006 + A2 2008 + A12:2010, EN 62233:2008

Milan, Italy, 21st April 2011

Chairman of the Board of Directors

Paolo Dalla Corte

EWG KONFORMITÄTSEKTLÄRUNG

Hersteller: **DALLA CORTE S.R.L.**

Mit Sitz in: Via Zambelletti 10, Baranzate (Milano), ITALIEN

Die Espresso-Kaffeemaschine entspricht den folgenden EWG-Richtlinien:

- Richtlinie über die elektromagnetische Verträglichkeit 2004/108/EG, unter Anwendung der folgenden Klauseln: EN 61000-3-2:2006 + A1:2009 + A2:2009, EN 61000-3-3:2008, EN 55014-1:2006 + A1:2009, EN 55014-2:1997 + A1:2001 + A2:2008
- Niederspannungsrichtlinie 2006/95/EC, unter Anwendung der folgenden Klauseln: EN 60335-1:2002 + A1:2004 + A11:2004 + A12:2006 + A2:2006 + A13:2008, EN 60335-2-75:2004 + A1:2005 + A11:2006 + A2 2008 + A12:2010, EN 62233:2008

Mailand, Italien, 21. April 2011

Vorstandsvorsitzender

Paolo Dalla Corte

DECLARACIÓN DE CONFORMIDAD CE

Fabricante: **DALLA CORTE S.R.L.**

Con domicilio social en: Via Zambelletti 10, Baranzate (Milan), ITALY

La máquina de café espresso es conforme a lo dispuesto en las siguientes normas:

- Directiva 2004/108/CE sobre Compatibilidad Electromagnética, con aplicación de las cláusulas de las siguientes normas armonizadas: EN 61000-3-2:2006 + A1:2009 + A2:2009, EN 61000-3-3 :2008, EN 55014-1:2006 + A1:2009, EN 55014-2 :1997 + A1:2001 + A2:2008
- Directiva 2006/95/CE sobre Baja Tensión, con aplicación de las cláusulas de las siguientes normas armonizadas: EN 60335-1:2002 + A1:2004 + A11:2004 + A12:2006 + A2:2006 + A13:2008, EN 60335-2-75:2004 + A1:2005 + A11:2006 + A2:2008 + A12:2010, EN 62233:2008

En Milán, Italia, a 21 de abril de 2011

El Presidente del Consejo de Administración

Paolo Dalla Corte

DÉCLARATION DE CONFORMITÉ

Fabricant: **DALLA CORTE S.R.L.**

Adresse du siège: Via Zambelletti 10, Baranzate (Milan), ITALY

La machine à café espresso est conforme aux prescriptions des normes suivantes:

- 2004/108/EC Directive compatibilité électromagnétique avec application des parties/clauses suivantes des normes harmonisées: EN 61000-3-2:2006 + A1:2009 + A2:2009, EN 61000-3-3:2008, EN 55014-1:2006 + A1:2009, EN 55014-2:1997 + A1:2001 + A2:2008
- 2006/95/CE Directive basse tension avec application des parties/clauses suivantes de normes harmonisées: EN 60335-1:2002 + A1:2004 + A11:2004 + A12:2006 + A2:2006 + A13:2008, EN 60335-2-75:2004 + A1:2005 + A11:2006 + A2 2008 + A12:2010, EN 62233:2008

Milan, Italie, le 21 avril 2011

Le Président du Conseil d'Administration

Paolo Dalla Corte



2002/96/EC

AVVERTENZE PER IL CORRETTO SMALTIMENTO DEL PRODOTTO AI SENSI DELLA DIRETTIVA EUROPEA 2002/96/EC

Alla fine della sua vita utile il prodotto non deve essere smaltito insieme ai rifiuti urbani. Può essere consegnato presso gli appositi centri di raccolta differenziata predisposti dalle amministrazioni comunali, oppure presso i rivenditori che forniscono questo servizio.

Smaltire separatamente il prodotto consente di evitare possibili conseguenze negative per l'ambiente e per la salute derivanti da un suo smaltimento inadeguato e permette di recuperare i materiali di cui è composto al fine di ottenere un importante risparmio di energie e di risorse.

INFORMATION FOR CORRECT DISPOSAL OF THE PRODUCT IN ACCORDANCE WITH EC DIRECTIVE 2002/96/EC

This product must not be disposed of as urban waste at the end of its working life. It must be taken to a special waste collection centre licensed by local authorities or to a dealer providing this service.

Separate disposal of the product will avoid possible negative consequences for the environment and for health resulting from inappropriate disposal, and will enable the constituent materials to be recovered, with significant savings in energy and resources.

ANWEISUNG FÜR DIE RICHTIGE ENTSORGUNG DES PRODUKTS GEMÄSS DER EG-RICHTLINIE 2002/96/EG

Dieses Produkt darf am Ende seiner Nutzungsdauer nicht im Restmüll entsorgt werden. Es muss in einer Entsorgungsstelle für Sonderabfälle, die von den örtlichen Behörden genehmigt ist oder bei einem Händler, der diese Dienstleistung anbietet, abgegeben werden.

Eine getrennte Entsorgung des Produkts verhindert mögliche negative Konsequenzen für Umwelt und Gesundheit, die aus einer unangemessenen Entsorgung entstehen und ermöglicht, dass die Inhaltsstoffe mit beachtlichen Einsparungen an Energie und Ressourcen wiederverwertet werden können.

ADVERTENCIAS PARA LA CORRECTA ELIMINACIÓN DEL PRODUCTO DE CONFORMIDAD CON LA DIRECTIVA EUROPEA 2002/96/CE

Al final de la vida útil del producto, este no deberá eliminarse junto con los residuos urbanos. Deberá entregarse al centro de recogida selectiva especial del Ayuntamiento o bien a una empresa que ofrezca servicios semejantes.

Eliminar por separado el producto evita posibles consecuencias negativas para el ambiente y la salud que pudieran derivarse de una eliminación inadecuada y permite recuperar los materiales que lo componen, con la finalidad de obtener un importante ahorro de energía y recursos.

INSTRUCTIONS POUR UNE ÉLIMINATION CORRECTE DU PRODUIT AUX TERMES DE LA DIRECTIVE EUROPÉENNE 2002/96/EC

À la fin de sa vie utile, le produit ne doit pas être éliminé avec des ordures ménagères. Il peut être remis aux centres chargés du ramassage sélectif prévus par les administrations communales ou bien chez des détaillants garantissant ce service.

Le fait d'éliminer le produit séparément permet d'éviter des conséquences négatives possibles sur l'environnement et sur la santé dérivant d'un traitement inadéquat; ceci permet également de récupérer les matériels dont il est fait pour garantir une économie importante d'énergie et de ressources.

DALLA CORTE S.R.L.
VIA ZAMBELETTI 10
20021 BARANZATE (MI) ITALY

T +39 02 454 864 43
info@dallacorte.com
www.dallacorte.com

Z-0004

